

# Technical Manual

## Glassfront Entry Vender

Models DN 59##, DN 33##

First Production 0001-8426BD (March 2005)



Operation  
Service  
Parts  
Troubleshooting  
Manual

Manufactured by



Dixie-Narco, Inc.  
P.O. Drawer 719  
Williston, SC 29853-0719  
800-688-9090  
803-266-5001  
fax: 803-266-5049  
Visit us on the web: [www.dixienarco.com](http://www.dixienarco.com)

803,904,030.01

# Table of Contents

<b>GENERAL INFORMATION.....</b>	<b>4</b>
Vender Safety Precautions .....	4
Product Identification .....	4
Physical Characteristics.....	4
<b>INSTALLATION &amp; SETUP .....</b>	<b>4 - 10</b>
Receiving Inspection.....	4
Unpacking The Vender .....	4
Electrical Requirements.....	5
Ground The Vender .....	5
Installation & Setup Instructions.....	5
Placing the Vender On Location.....	6
Leveling the Vender.....	6
Spacing the Vender .....	6
Installing Labels & Flavor Cards.....	7
Coin Changers And Other Accessories.....	7
Set Temperature Control .....	7
Loading the Vender .....	8
Loading the Coin Changer .....	9
Power Distribution Box .....	9
Vending Machine Controller (VMC).....	9
Keypad.....	9
Digital Display.....	9
Refrigeration System .....	9
Shelf Assembly .....	9
Shelf Stabilizer .....	10
Gate Assembly .....	10
Slide / Pusher Assembly .....	10
Helix (Spirals).....	10
Kicker.....	10
Motor Assembly.....	10
<b>PROGRAMMING .....</b>	<b>11 - 22</b>
General .....	11
External Display Items .....	11
Normal Operation Messages .....	11
Initial Programming.....	12
Quick Reference Menu Items.....	13
Service Mode .....	14 – 15
Test Mode .....	16 – 18
Setup Mode .....	19 – 20
Setup Mode 2.....	21 - 22
<b>GENERAL MAINTENANCE .....</b>	<b>23 - 24</b>
Power.....	23
Cleaning.....	23
Eprom Replacement .....	24
<b>MAJOR COMPONENT DESCRIPTION .....</b>	<b>25</b>
AC Distribution Box .....	25
Refrigeration Unit.....	25
<b>ELECTRICAL DIAGRAMS &amp; SCHEMATICS.....</b>	<b>26 - 27</b>
MDB Controller Connections.....	26
Dual Sensor Board .....	27
<b>TROUBLESHOOTING .....</b>	<b>28 – 37</b>
Coin Acceptance .....	28
Bill Acceptors.....	28
Control Board.....	28
All Coins Rejected.....	29
All Bills Rejected.....	30
Incorrect Change Dispensed.....	31
Selection Will Not Vend .....	32

Ice / Frost on Evaporator .....	33
Condensate on Outside of Product Door.....	33
Compressor Will Not Stop.....	33
Compressor Will Not Start .....	34
Machine Not Cooling .....	35
Selection Will Not Vend .....	36 - 37
<b>ELECTRICAL DIAGRAMS &amp; SCHEMATICS .....</b>	<b>38 - 43</b>
Vender Wiring Diagram .....	39 - 39
Compressor Wiring Diagram.....	40
Domestic AC Distribution Box Schematic.....	41
AC Distribution Box J2 Port Voltages.....	42
Assembly, Domestic AC Distribution Box T8 Electronic.....	43
<b>PARTS LIST AND DIAGRAMS .....</b>	<b>45 - 75</b>
Machine Front View.....	45 - 46
Recovery Unit.....	47
Cabinet Detail.....	48 - 49
Service Door Front .....	50 - 51
Service Door Inside A.....	52 - 53
Service Door Inside B.....	54 - 55
Tall Tray Detail .....	56 - 57
Snack Trays / Helix.....	58 - 59
Snack Trays Detail .....	60 - 61
AC Distribution Box .....	62 - 63
Lighting .....	64
Refrigeration Unit DN59##/33## Fin & Tube Condenser .....	65 - 66
Electronics.....	67
Harnesses.....	68 - 69
Labels / Decals / Misc.....	70
Screws & Nuts.....	71 - 72
Washers, Bolts, & Misc. Hardware.....	73 - 75

# GENERAL INFORMATION

## VENDER SAFETY PRECAUTIONS

Please read this manual in its entirety. This service information is intended for use by a qualified service technician who is familiar with proper and safe procedures to be followed when repairing, replacing or adjusting any Dixie-Narco vender components. All repairs should be performed by a qualified service technician who is equipped with the proper tools and replacement components, using genuine Dixie-Narco factory parts.



Warning

*REPAIRS AND/OR SERVICING ATTEMPTED BY UNQUALIFIED PERSONS CAN RESULT IN HAZARDS DEVELOPING DUE TO IMPROPER ASSEMBLY OR ADJUSTMENTS WHILE PERFORMING SUCH REPAIRS. PERSONS NOT HAVING A PROPER BACKGROUND MAY SUBJECT THEMSELVES TO THE RISK OF INJURY OR ELECTRICAL SHOCK WHICH CAN BE SERIOUS OR EVEN FATAL.*

**IMPORTANT NOTE:** This machine should not be used to vend perishable products without the Health Control Kit (622,010,20x.x4) installed. If you wish to vend perishable products, please contact Dixie-Narco for assistance.

## PRODUCT IDENTIFICATION

First production of Entray Venders April 2005.

The production date of Dixie-Narco products is determined by the date code incorporated in the serial number.

The vender serial number takes the form xxxx-yyzz. The first 4 digits (xxxx) identify the specific vender. The next 4 digits (yyzz) identify the manufacturing run that the vender was built in. The last two alpha characters (zz) identify the quarter and the year the vender was built. The first alpha character identifies the quarter as follows:

- A= 1<sup>st</sup> Quarter
- B= 2<sup>nd</sup> Quarter
- C= 3<sup>rd</sup> Quarter
- D= 4<sup>th</sup> Quarter

The second alpha character identifies the year:

- D = 2005                      H = 2009
- E = 2006                      I = 2010
- F = 2007                      J = 2011
- G = 2008

## PHYSICAL CHARACTERISTICS

	DN 59##
<b>HEIGHT</b>	72" (1828.8 mm)
<b>WIDTH</b>	43" (1092.2 mm)
<b>DEPTH</b>	32" (812.8 mm)
<b>BASE</b>	4.5" (114.3 mm)
<b>SHIPPING WEIGHT</b>	694 lbs. (314.8 kg)
Glass door is 33" (838.2 mm) wide, 56" (1422.4 mm) high	

	DN 33##
<b>HEIGHT</b>	72" (1828.8 mm)
<b>WIDTH</b>	32.5" (825.5 mm)
<b>DEPTH</b>	32" (812.8 mm)
<b>BASE</b>	4.5" (114.3 mm)
<b>SHIPPING WEIGHT</b>	545lbs. ( 246.9 kg)
Glass door is 23.08" (586.23 mm) wide, 56" (1422.4 mm) high	

## RECEIVING INSPECTION

**DO NOT STORE THE VENDER OUTSIDE.**

Upon receipt, inspect the vender for any shipping damage. If there is any damage, have the delivery driver note the damage on the bill of lading and notify Dixie-Narco. Although the terms of sale are FOB shipping point, which requires the consignee to originate shipping damage claims, Dixie-Narco will gladly help if you must file a claim.

## UNPACKING THE VENDER

Remove the stretch wrap, fiberboard edge protectors and corrugated front protector from the outside of vender.



Do not store the vender with stretch wrap on. Stretch wrap could bond to the vender's surface, which could damage the finish.

Remove the shipping boards from the bottom of the vender. The shipping boards are attached by the leveling legs. To avoid unnecessary damage to the leveling legs or base, remove the shipping boards by using a 1-1/2 inch socket type wrench to unscrew the

# INSTALLATION & SETUP

leveling legs. Be sure to replace the legs after removing the shipping boards.

Once the vender is unpacked, check the recovery unit for any additional parts, price/ product labels, service/operation manual or other information concerning factory-equipped accessories such as coin mech and validator.



**WARNING: TO AVOID THE POSSIBILITY OF A FIRE HAZARD, DO NOT STORE ANYTHING OR ALLOW DEBRIS OF ANY KIND TO ACCUMULATE IN THE BOTTOM OF THE SERVICE AREA, IN AND AROUND THE REFRIGERATION COMPARTMENT OF THE CABINET, OR IN FRONT OF THE EVAPORATOR AND CONDENSER COILS.**



WARNING: ENSURE THAT POWER IS DISCONNECTED FROM THE VENDER OR THAT THE POWER INTERRUPT SWITCH IS NOT DEFEATED BEFORE INSPECTING OR REPLACING THE LAMPS, OTHER ELECTRICAL COMPONENTS, OR WORKING WITH OR ADJUSTING THE VENDING MECHANISM. FAILURE TO COMPLY WITH THESE INSTRUCTIONS MAY SUBJECT THE USER TO THE RISK OF ELECTRICAL SHOCK OR MECHANICAL INJURY, WHICH CAN BE SERIOUS OR FATAL.



## ELECTRICAL POWER NEEDED

Refer to the cabinet serial number plate to determine the proper voltage and frequency the machine requires (domestically, this requirement is 120 Volts, 60 Hertz). The cabinet serial plate also indicates the amperage of the vender. The vender must be plugged into a properly rated, single phase alternating current outlet with its own circuit protection (fuse/circuit breaker).

**DO NOT USE AN EXTENSION CORD.**

## GROUND THE VENDER

The vender is equipped with a three-wire power supply cord and **MUST** be plugged into a properly grounded outlet.



DO NOT REMOVE THE GROUND PIN OR IN ANY WAY BYPASS, MODIFY, DEFEAT, OR DESTROY THE GROUNDING SYSTEM OF THE VENDER.

If the outlet will not accept the power cord plug, contact an electrician to install a proper AC outlet.



FAILURE TO COMPLY WITH THESE INSTRUCTIONS MAY SUBJECT THE USER TO THE RISK OF INJURY OR ELECTRICAL SHOCK WHICH CAN BE SERIOUS OR FATAL. PERIODICALLY INSPECT THE POWER SUPPLY CORD FOR DAMAGE. IF THE CORD BECOMES DAMAGED IT MUST BE REPLACED WITH THE SAME SIZE AND TYPE CORD. CONTACT DIXIE-NARCO FOR ASSISTANCE.

## INSTALLATION AND SETUP INSTRUCTIONS

Open the service door on the right side using the key provided in the coin return cup, or if shipped with a locking clip, remove the clip and install the lock. Ensure there is no power to the AC Distribution Box. On venders with a main power switch on the AC Distribution Box the switch needs to be in the OFF position. On venders with a main power quick disconnect plug on the AC Distribution Box the quick disconnect plug needs to be unplugged. Check that all connectors are firmly seated on the control board and at the various components on the service door (coin mech, keypad, etc.).

Retrieve the main power plug from the hole in the rear of the vender and plug the cord in a properly grounded 120VAC, 15 Amp receptacle (U.S. and Canada).

Open the service door and apply power to the AC distribution Box (if equipped with a bill acceptor, the acceptor should cycle twice). The display on the door should scroll the message "USE EXACT CHANGE", the fluorescent lamp should be lit and the cooling unit should start.

If the display scrolls "OUT OF SERVICE", or the cooling unit fails to start, refer to the TROUBLESHOOTING FLOWCHARTS beginning on page 28.

# INSTALLATION & SETUP

## SERVICE NOTE

### Battery Backup

The battery backup is used to retain information programmed in the system (pricing, time, date, etc.) in case of power interruptions, or any time the main power is off. When the vender is shipped, the battery is connected and memory is being maintained. If the vender is to be stored for long periods of time, disconnecting the battery is recommended. The following steps will guide you through this procedure:

Open the service door and unplug the main power harness located on the front of the power box.

1. Locate the main control board mounted on the right side wall.
2. On controllers with a cover, remove the screw securing the cover to the board.
3. The backup system jumper is located just below the battery near the center of the board (refer to figure 1, page ##).
4. Remove the jumper covering the pins and place it on only one pin for storage.
5. Reinstall the cover, if used, and tighten the screw.
6. Reverse this procedure to connect the battery.

## PLACING THE VENDER ON LOCATION

### !! CAUTION !!



*DO NOT TRANSPORT THE VENDER TO OR FROM THE LOCATION LOADED WITH PRODUCT OR DAMAGE TO THE VENDER MAY RESULT.*

The vender is intended for **INDOOR USE ONLY**. It should be kept out of direct sunlight and away from any heat source.

The vender must be on a solid, flat and level surface. Ensure the flooring can bear the weight load of a fully loaded vender (approximately 1150 lbs.). The vender must be positioned close enough to an electrical outlet so that an extension cord is not required. If the machine will be subject to user misuse or vandalism, it is recommended that the vender be secured to the floor or wall as described in Dixie-Narco Technical Bulletin 344. Due to the large size and weight of the Vender, never attempt to move the Vender with a Hand Truck or Stair Climber. Use a pallet jack or Vender/Cooler Dollies at all times when moving the Vender. The vender should never be slid or pushed in place. Never side load the leveling legs; doing so will cause damage to the legs. Do not transport the vender to or from customer locations loaded with product, as damage may result due to excessive weight. Call the Dixie-Narco Technical Service

Department or your Dixie-Narco Representative for assistance.

## LEVEL THE VENDER

Adjust the front leveling legs, ensuring that an even gap exists between the glass door and the top security angle and receiver box, and then level the cabinet front to rear. A carpenter's level will help verify that the vender is level. Leveling legs are adjusted using a wrench or socket 1 1/2" in size. If the vender is to be used in a bank of equipment, check the top and sides for proper alignment. If you are unable to properly level the vender, select an alternate location. **NEVER PLACE OBJECTS UNDER THE LEVELING LEGS OF THE VENDER**

## DANGER

*THE VENDER MUST BE PROPERLY LOCATED AND LEVELED. IF THE MACHINE WILL BE SUBJECT TO USER MISUSE OR VANDALISM IT IS RECOMMENDED THAT THE VENDER BE SECURED TO THE FLOOR OR WALL AS DESCRIBED IN DIXIE-NARCO TECHNICAL BULLETIN 344 TO MINIMIZE THE RISK OF INJURY OR DEATH FROM TIPPING. CALL THE DIXIE-NARCO TECHNICAL SERVICE DEPARTMENT OR YOUR DIXIE-NARCO REPRESENTATIVE FOR ASSISTANCE.*



## SPACE THE VENDER

Do not block the rear of the vender. Maintain a minimum of 4 inches (10 cm) from the wall to ensure adequate airflow to the condenser and compressor. At the front of the vender, make sure that nothing obstructs the air intake at the bottom of the service door and cabinet. At the rear of the vender, make sure nothing obstructs the air exhaust at the bottom of the cabinet.

## WARNING

*TO AVOID THE POSSIBILITY OF A FIRE HAZARD, DO NOT STORE ANYTHING OR ALLOW DEBRIS OF ANY KIND TO ACCUMULATE IN THE BOTTOM OF THE DOOR, IN THE BOTTOM OF THE SERVICE AREA, IN AND AROUND THE REFRIGERATION COMPARTMENT OF THE CABINET, OR IN FRONT OF THE EVAPORATOR AND CONDENSER COILS.*



# INSTALLATION & SETUP

## INSTALLING PRICE LABELS

Pricing labels included in the literature package kit. They are double sided and range in price from .25 to 9.95. The price labels are inserted at the top of the front knuckle of each release mechanism.

Remove the pricing label sheets from the service manual package and gently remove the label corresponding to the vend price of each selection by tearing at the perforation. The label is inserted between the grooves at the top of the front knuckle by slightly bending sides of the label toward the front of the vender being careful not to crease the label. Once inserted, push the label firmly against the front of the knuckle. This will insure the label is locked in place and will not fall out during normal operation of the vend mechanism.

## INSTALLING FLAVOR CARDS

For problem free vending, it is necessary to load the venders columns consistently with same product every time the vender is filled. To ensure consistent loading, flavor cards are included for the slide assemblies with every vender and should be installed into the product pusher to designate to the route driver which product the column is set for.

To install the flavor card, simply detach it from the sheet at the perforation and slide it into the slots in the product pusher.

## COIN CHANGERS & OTHER ACCESSORIES

The vender must have an MDB coin changer installed and can have an MDB bill acceptor installed as well. If the MDB coin changer and other MDB accessories are not factory installed, refer to the instructions received from the manufacturer of the MDB coin changer and other MDB accessories for proper set-up and installation.

The vender will support the following Domestic MDB coin changers:

Coinco 9302GX, USG-701 Quantum  
Mars TRC-6510, TRC-6512, TRC-4010  
Conlux CCM-5G 1-2-3-4-5

The vender will support the following domestic MDB Bill validators:

Coinco BA-30 B, BA-50B      Coinco Mag 50  
Mars VN 2512                  Conlux NBM-3000 Series

The vender will support the following MDB card readers:

Debitek                                  VMC LTD  
Danyl Schlumberger                  Fage  
Diebold Systems                      Jofemar  
AT&T Campus Wide                  Evend.net  
Danyl Smartcard

The above listed peripherals indicate units that have been tested by Dixie-Narco at the time of printing of this manual and are not all-inclusive. For information regarding other types not listed here, please contact Dixie-Narco Technical Service Department.

## SETTING THE TEMPERATURE CONTROL

This vender is equipped with a manual thermostat. It is located on the power distribution box inside the service area. This thermostat is factory pre-set to maintain a cabinet temperature of 33 to 38 degrees Fahrenheit (1 to 3 degrees centigrade), however, occasional adjustment may become necessary. It is also a good practice to ensure the proper operating temperature prior to installing the vender on location.

To set the temperature, apply power to the vender and allow it to run for several hours with the glass door closed or until the minimum cabinet temperature is achieved. Then, using one of the methods below, verify the temperature inside the cabinet:

1. If your vender is equipped with an electronic temperature sensor, use the keypad on the service door to show cabinet temperature in Fahrenheit by pressing the F key followed by the asterisk (\*) key or in Centigrade by pressing the C key followed by the asterisk key. The temperature will be shown on the digital display located on the front of the service door.
2. If your vender is not equipped with a temperature sensor, place a thermometer in the center of the C shelf when vender is first powered up. Make sure the thermometer is placed in a location that permits reading the temperature with the glass door closed. This will prevent the introduction of warm, ambient air.

Adjustments are made by turning the screw in the center of the control (Shown in fig. 1) clockwise for colder product or counterclockwise for warmer product. It is recommended that the control screw be adjusted in very small increments allowing the refrigeration unit to cycle off and then verifying the temperature again using one of the methods listed above prior to further adjustment.



Fig 1  
Temperature Control  
Adjustment. (Arrow  
shows location of  
adjustment screw)

# INSTALLATION & SETUP

## LOADING THE VENDER

### CAN/BOTTLE DRINK TRAYS

All venders are shipped with an assortment of spacers. Please contact a Service Representative or refer to the proper Technical Publication for spacer settings.

Load product in each column one package at a time insuring that the package being loaded is in front of the product pusher. If the package is narrower than the column, use the correct spacer to insure a snug (not tight) fit against the left side of the column. Test the column spacing by pulling firmly on the front package. If the package pulls out of the column easily, recheck the spacer being used. Also insure that the package is stable within the column (doesn't move excessively from side to side). Some packages are wider at the base than in the center. These packages will have the tendency to lean forward on the front of the gate assembly and create a jam if not properly set up. A properly loaded column will allow the product to slide freely into the gate area but not allow the product to squeeze past the front knuckle of the release mechanism. After loading the vender, test vend each column to insure proper operation.

### SNACK/FOOD TRAYS

All venders are shipped with the factory set Entry trays settings. Please contact a Service Representative or refer to the proper Technical Publication for alternative trays, spirals, and other parts available for other package settings.

The trays will pull forward and tilt down to ease loading. Load the packages from the back to the front. Correct loading will prevent service calls and ensure proper vending. After loading for the first time, test vend each selection with money until the first product is delivered. This will ensure the vender is loaded and working properly.

## Initial Loading

The end of the bar (single) helix locates approximately at the 5-6 o'clock position and the bag (double) helix locates approximately at the 7-8 o'clock position for a left helix and 4-5 o'clock for a right helix to ensure proper vending. See figures 2 and 3.

### **IMPORTANT**

**THE SNACK TRAY ASSEMBLIES WILL TILT DOWN TO EASE LOADING. WHEN LOADING, PULL THE TRAY ASSEMBLY ALL THE WAY FORWARD.**

Load the packages from the back to the front. Correct loading will prevent service calls and ensure proper vending.

*Note: It is important to adjust the spacer bar assembly to ensure proper vending of bars. Also, bar packages should fit loosely in the helix. Candy bars that fit tightly in the helix should be vended from a helix with fewer spaces (17 instead of 20).*

After loading a vender for the first time, test vend each selection with money until the first product is delivered. This will ensure the vender is loaded and working properly.

*Note: To ensure proper airflow through the evaporator, do not place product (or other foreign objects) in the bottom of the product area.*

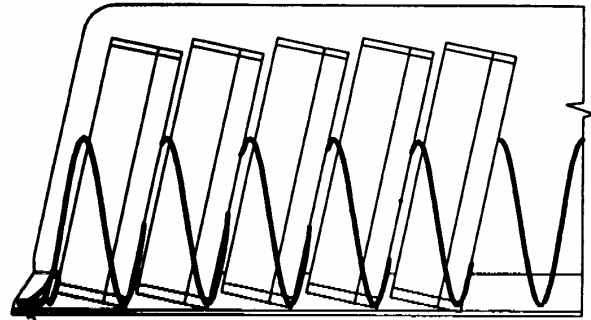

**Product Pusher**

Correct Loading for Bars  
Figure 1A

Correct Loading for Bags

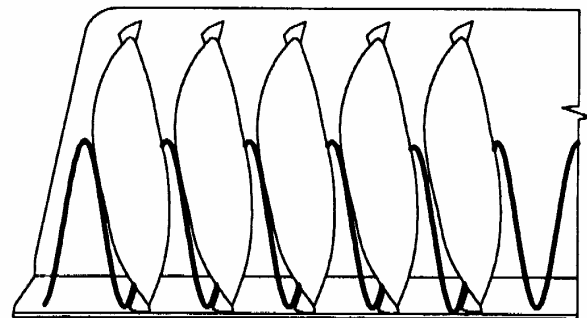
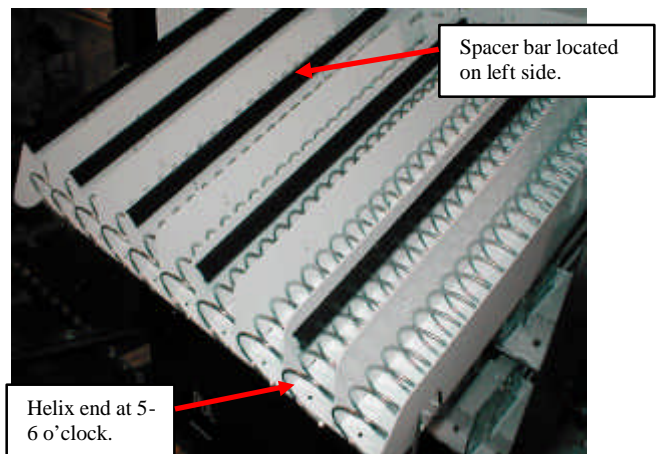

Figure 1B

Fig



Bar Tray Assembly



# INSTALLATION & SETUP

Figure 2

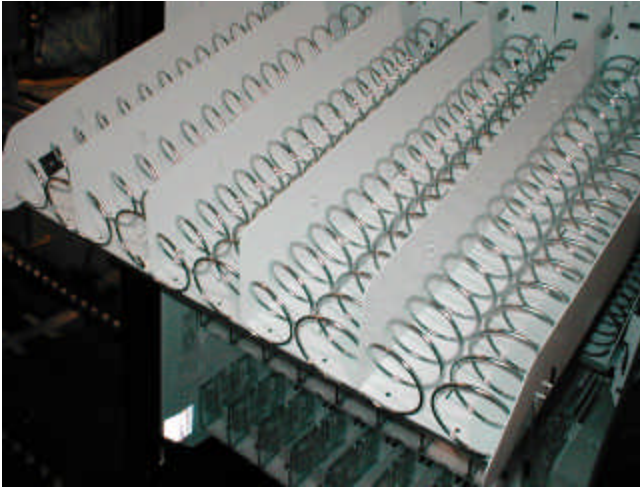

Bag Tray Assembly  
Figure 3

## LOADING CHANGE TUBES

The changer tubes can be loaded using one of the following methods:

1. Load the coin mechanism with coins to the desired level by inserting coins in the loading slots on the coin tube front.

Minimum coin tube levels are:

6-8 nickels

7-8 dimes

5-6 quarters

Note: A low coin level in the coin tubes will interfere with operation of the bill validator.

2. For exact cash accountability and to insure maximum dollar bill acceptance, load the mechanism utilizing the coin insert slot on the front of the vender while in the coin tube fill/dispense mode in the test menu. (see page 17 in the programming section for more information)

(For additional information about coin mechanism, refer to the manufacturer's instructions.)

## POWER DISTRIBUTION BOX

The power distribution box is where the 120VAC input voltage is broken down to the main operating voltages of the vender (24 VAC and 12 VAC) by a transformer. Those voltages are sent to the controller via the J1 (12 pin) connector. It also contains 3 fuses that protect the VMC, transformer, and solenoids. The power distribution box also distributes AC power to the lights, evaporator fan, and refrigeration system, which are always energized when the vender is powered up. It is located inside the service area, mounted to the back wall.

## VENDING MACHINE CONTROLLER (VMC)

The vending machine controller is the heart of the Glass Front Vender and is located on the right side wall inside the service area. It contains the program chip (EPROM), which controls all aspects of the vender with the exception of the refrigeration unit and lighting. It also contains the power supply which regulates the voltages required to operate the vend solenoids as well as the changer, coin mechanism, digital display and all logic functions in the vender.

## Keypad

The keypad is located on the front of the service door. It consists of a 6 inch X 3 inch matrix, membrane switch pad and a rubberized actuator pad. The pad utilizes the letters A thru F on the left side and numbers 1 thru 0 along with the \* symbol and Clr to the right. The keypad is where the vender programming is accomplished and where the customers make their selections.

## DIGITAL DISPLAY

The digital display is located directly above the keypad on the front of the service door. It is an 8 digit 14-segment alphanumeric display. It is used to convey information to the consumer as well as to the person programming the vender. The backside of the digital display, inside the service door, contains the service mode switch. It is a blue button that is depressed a number of times in order to access different programming menus.

## REFRIGERATION SYSTEM

The refrigeration system is a single piece unit and is hermetically sealed. In the DN59###/DN33### models consist of a ½ horsepower compressor, with a single fin and tube style condensing unit with one fan, the condensation overflow pan and the evaporator. The evaporator is located behind the panel on the right side of the cooling compartment directly adjacent to the bottom shelf. The remainder of the unit is located behind the delivery bin, mounted to the bottom of the cabinet. This unit is designed for easy removal and replacement from the front of the vender as a complete assembly. An electronic thermostat regulates the cabinet temperature. The bulb of the thermostat is attached to the evaporator coils and reads the temperature of the refrigerant inside the coil.

## SHELF ASSEMBLY

Typically, there are 5 shelf assemblies in every vender; however, this can vary depending upon the configuration specified at the time of ordering. Each can/bottle shelf consists of 6, 8, or 9 columns. Each shelf is capable of holding a variety of products. The shelf assembly consists of the tray, where all of the following parts are mounted: Gate assembly, shelf

# INSTALLATION & SETUP

stabilizers and the slide/pusher assembly. Each snack/food shelf consists of 5, or 11 columns. Each shelf is capable of holding a variety of products. These items are discussed in detail below.

## **SHELF STABILIZERS**

Some packages will have the tendency to become unstable or bounce to the delivery bin when vended due to the design of the bottom of the package. This can lead to a product jam. The shelf stabilizer (the clear Lexan tab at the front of the tray) is used to prevent this from occurring by acting as an extension of the shelf.

Unless otherwise specified at the time of ordering, shelf stabilizers are installed on the C and D shelves of the vender. The stabilizers that are installed on the C shelf can also be used on the A and B shelves as needed for product stability. The stabilizers installed on the D shelf must be used only on that shelf as they are longer and may interfere with the proper vending of a column. Do not use shelf stabilizers on the bottom tray as product jams may occur.

To install the stabilizers, the slide assembly must first be removed from the column. The stabilizer is inserted on the bottom of the slide assembly by firmly pushing the square hole in the stabilizer onto the front locking tabs of the slide. The slide is then installed back into the column.

## **GATE ASSEMBLY (Can/Bottle Trays)**

The gate assembly is mounted on the front portion of the tray assembly and contains the vending mechanism. Incorporated in the gate assembly are the front and rear knuckle assemblies as well as the product kicker.

In standby operation, the front knuckle is in the blocking position, which holds the front (displayed product) in position to be vended. The rear knuckle assembly is in a flat position, which allows product to enter the gate area, and the kicker is flush to the rear knuckle assembly. A stainless steel pin is inserted through the rear most portion of the front knuckle assembly and connects to a solenoid plunger below the tray. When a selection is made, the solenoid energizes pulling the plunger toward the back of the tray. At the same time the front knuckle is opened into a flat position, the rear knuckle is closed to a blocking position, holding the remaining product out of the gate area, and the kicker is extended to firmly push the front (displayed product) off of the tray. The solenoid is energized for approximately 1-½ seconds to allow ample time for the displayed product to be ejected from the shelf. The solenoid is then released and the front knuckle returns to the blocking position, the rear knuckle and kicker return to their standby position and the next product slides into the vend (display) position.

## **SLIDE/PUSHER ASSEMBLY (Can/Bottle Trays)**

The slide/pusher is located on the bottom of each product column. Its purpose is to provide a slick, friction resistant surface for the product to rest on. The product pusher is mounted on the top of the slide and incorporates a coil spring in the body that attaches to the bottom of the slide through a slit. This spring adds needed tension to insure that all products in the column remain tight against each other and are allowed to progress into the gate area.

Although these pushers reduce the effects of dirt and grime, periodic cleaning and lubrication of the slides is recommended. **DO NOT USE SOLVENTS OR ABRASIVE MATERIALS TO CLEAN ANY PORTION OF THE TRAY.**

## **HELIX (SPIRAL) (Snack/Food Trays)**

The helix is located in each column. Its purpose is to deliver the package. The helix is mounted in the column and attaches to the motor. Although the helix itself is not affected by the effects of dirt and grime, periodic cleaning of the tray chassis is recommended.

## **KICKER (Snack/Food Trays)**

The kicker is located on the end of the helix when used. Its purpose is to push the product off the tray for delivery.

## **MOTOR ASSEMBLY (Snack/Food Trays)**

The motor assembly is located at the back of each product column. Its purpose is to drive the helix to deliver the product. The motor assembly is mounted on the back of the tray assembly and snaps in to position.

# PROGRAMMING

## GENERAL INFORMATION

In order to fully utilize the many features of your vender it is important that you first understand the options available and procedures for programming the vending controller unit (control board).

All programming, testing, and service functions are accomplished by using the keypad in an easy to follow, display prompted format. There are four modes of operation for servicing, testing, and setting up your vender. The modes of operation are accessed by, opening the service door, and pressing the service button (blue button on back of display module or the service button on the control board).

The service button will cycle through each of the four modes in turn: Service Mode, Test Mode, Set-Up Mode and Setup Mode 2. In each of these modes, the "A" key is used to scroll through the available options/settings within that mode/selection. (Note: In each of the mode selections, pressing the character key next to the listed option will take you directly to that feature - see menu items chart on page 12.), the "\*" key is used as an enter key to select the currently displayed item/feature, and the "CLR" key is used as a done or exit key. Closing the service door or pushing the service door switch will exit the function you are currently in and place the vender back in service.

## EXTERNAL DISPLAY ITEMS (HOT KEYS)

Allows the service technician to view several items via the display without opening the vender. There are four options that can be viewed externally:

1. **Display temperature in degrees "C"**. To view, press the "C" then press the \* key. The display will then show the vender's inside temperature in degrees "C". Note: The temperature will only display if temperature sensor hardware kit is installed.
2. **Display date/time**. To view, press the "D" key, then press the "\*" key. The display will then show the current date and time.
3. **Display power condition** as a number value. Typical value ranges between 30V and 34V. To view, press the "E" key, then press the "\*" key. The display will show the vender's current power condition.
4. **Display temperature in degrees "F"**. To view, press the "F" key, then press the "\*" key. The display will show the vender's inside temperature in degrees "F". Note: This will only display if temperature sensor hardware kit is installed.
5. **Selection status messages**. When selecting an item that can not be vended the display will show one of the following:
  - a. **"Not Available Until HHMM"** – The selection is blocked under the Not Available setting and will become available at the indicated time.

- b. **"Select Another Item <code>"** – The selection can not vend due to the error code indicated. The code can be one or more of the following:
  - i. **"N"** – Controller has determined the solenoid is missing.
  - ii. **"V"** – Controller detected a solenoid fault on this selection.
  - iii. **"H"** – Selection has been blocked under Health Guard.
  - iv. **"D"** – Selection has been blocked by Enabled Item mode.
  - v. **"Sold Out"** – Product was not detected after previous vend and controller has marked selection as sold out.
  - vi. **"Cool In ### Minutes"** – Selection has been placed under cool down control and will be available at the indicated time.
6. **DEX status messages**. The controller will display the result of a DEX transfer for 2 seconds upon completion.
  - a. **"DEX OK"** – No communication errors occurred, the DEX transfer was completed successfully. Some handheld devices may perform their own processing of DEX data after a transfer. The success of such operations is independent of this status indication.
  - b. **"DEX ERR"** – A communication error occurred. This can include a handshake error, an incorrect response, or no response from the audit device.
  - c. **"DEX PW"** – A DEX operation was attempted with out a valid DEX password. The operation did complete successfully.
7. **Error Alert**. When the service door is opened, the controller will beep 3 times and display "CHK ERRS" to alert service personnel to the presence of error conditions. The service personnel should proceed to the List Errors function in Test Mode to determine the failure.

## NORMAL OPERATION MESSAGES

At initial power-up, the program will start and the display will briefly show the software version in use as VER####.## (i.e. 930.01), followed by the default idle message, "ENJOY A REFRESHING DRINK & SNACK NOW", or the user entered point of sale message unless these are overridden by a higher priority status message.

# PROGRAMMING

## INITIAL PROGRAMMING

### DATE/TIME

Proper setting of items such as Happy Hour and Not Available Times, as well as obtaining information regarding Door Openings, Power Outages, etc. depend on a correct DATE/TIME setting. This setting, while set at the factory, should be checked and changed if necessary. Enter "SETUP MODE" by opening the service door and pressing the Service Button 3 times. Press the number 5 key; the day, date, and time will scroll across the display in the following format: SUN 09/08/02 1330. To change press the "\*" key and the display will read "SAT". Use the "A" key to scroll through the days. When the desired day is displayed, press the "\*" key. The display will read "MONTH". Enter the 2 digits for the month and press the "\*" key. The display will read "DAY". Enter the date (2 digits) and press the "\*" key. The display will read "YEAR". Enter the year (last 2 digits) and press the "\*" key. The display will read "HOUR". Enter the hour (00 – 23) and press the "\*" key. The display will read "MIN". Enter the minutes (00 – 59) and press the "\*" key. The date/time is now set and the display will return to "SETUP MODE".

### REGULAR PRICES

To set the prices enter the "SERVICE MODE" by opening the service door and pressing the Service Button once. Press the number 7 key; the display will scroll "SET REGULAR PRICES". Then "\$0.00" will be displayed. As the prices are entered the numbers will shift in from the right on the display. When the desired price is displayed it may be assigned to an individual selection, an entire tray (shelf), or to all selections in the machine. When setting prices for individual selections DO NOT press the "\*" key. The "\*" key is only used to assign a price to an entire tray or to all selections in the machine. When setting one price for an entire tray the "\*" key is pressed after designating the tray (display reads \$1.00 A), when the "\*" key is pressed the display will read "\$1.00 A" momentarily, then will return to just the price. When setting one price for an entire machine the "\*" key is pressed after entering the price (display reads \$1.00), when the "\*" key is pressed the display will read "\$1.00 \*" momentarily, then will return to just the price. When setting prices for individual selections the tray and column (A1) is entered following the price. As soon as the column number is pressed, the price and selection will be displayed momentarily (" \$1.00"), then the display will return to just the price. Always check the setting for "MAX CREDIT" before setting prices (not applicable to International machines).

### POINTS TO REMEMBER:

- Prices entered must not exceed the "MAX CREDIT" set in the system's program.

- DO NOT press the "\*" key when setting prices for individual selections.

### SET NOT AVAILABLE TIMES

Password protected. Before entering or changing this setting you must enter the password if one has been assigned. This mode allows up to 4 different time periods that use of the machine may be restricted. To set Not Available Times enter the "SETUP MODE" by opening the service door and pressing the Service Button 3 times. Press the number 3 key; the display will scroll "SET NOT AVAILABLE TIME". Press the "\*" key and the display will show "SHUTDOWN". Press the "A" key and the display will show "BLOCK 1" which allows selection set up. Press the "\*" key and the controller will begin displaying selections currently belonging to block until all have been displayed or the "\*" key is pressed and display will show "ITEM". There are now three (3) choices:

- 1) ALL SELECTIONS. Press the "\*" key and all selections in the vender will be set for not available.
- 2) ONE TRAY. Pressing the letter of the shelf (tray) followed by the "\*" key will set control for all selections on that shelf.
- 3) SINGLE SELECTION. Press the desired selection number or numbers corresponding to the selections that require the set not available times.

Press the key buttons again and the display will flash "DISABLED" and return to "ITEM". Priority will be given to the higher ranked method. If one selection on the A tray was set to "ENABLE" using option 3 above and you wish to change the remaining selections on that tray using option 2, the Setting for the entire tray would take precedence. Conversely, if the tray was set using option 2 first followed by the single selection using option 3, the setting for the remainder of the shelf would remain and the new set not available setting would take affect. If "DISABLED" the selection will be blocked during the scheduled time period. Press the "CLR" key will exit the selection setup & start the schedule setup. "START TIME" will scroll on display once and change to "HOUR 00". Enter the hour (00 – 23) and press the "\*" key. The display will read "MIN 00". Enter the minutes (00 – 59) and press the "\*" key. "END TIME" will scroll on display once and change to "HOUR 00". Enter the hour (00 – 23) and press the "\*" key. The display will read "MIN 00". Enter the minutes (00 – 59) and press the "\*" key. "DAY" will show on the display. To change press the "\*" key and the display will read "SAT". Use the "A" key to scroll through the days. When the desired day is displayed, press the "\*" key. Press the "CLR" key to move to "BLOCK 2".

### POINTS TO REMEMBER:

- Before setting Not Available times and days, it is recommended you check the DATE/TIME settings.
- All times entered must be in 24 hour format.

# PROGRAMMING

---

## SERVICE MODE MENU ITEMS

### SERVICE MODE

- A Next Item
- B Cash Box
- C Sales
- D Display Temperature
- E Not Used
- F Clear Totals
- 1 Number Sold
- 2 Enable Item
- 3 Sales by Column
- 4 Escrow
- 5 Force Vend
- 6 Audio Feedback
- 7 Set Regular Prices
- 8 Not Used
- 9 Relay Toggle Test
- 0 Clear Errors

### SETUP MODE

- A Next Item
- B Not Used
- C Not Used
- D *Enable/Disable \$*
- E Not Used
- F *Master Reset*
- 1 *Snack Shelf Set Up*
- 2 Not Used
- 3 *Set Not Avail. Time*
- 4 *Display Reset*
- 5 *Date/Time*
- 6 *Total Sales*
- 7 *Health Control Enabled/Disabled*
- 8 *Drop Sensor Enabled/Disabled*
- 9 Not Used
- 0 *Enter New Password*

---

### TEST MODE

- A Next Item
- B List Errors
- C Self Test
- D Display Test
- E Keypad Test
- F Auto Sequence
- 1 Tube Fill/Dispense
- 2 Daylight Savings Time
- 3 Set Not Available Mode
- 4 Set Credit Timer Mode
- 5 Door Open
- 6 Power Out
- 7 Test Health Guard
- 8 Display Health Guard
- 9 Test Vend
- 0 Clear Errors

---

### SETUP MODE 2

- A Next Item
- B STS Enabled/Disabled
- C Custom STS Configuration
- D Default STS Configuration
- E Display STS Configuration
- F Not Used
- 1 Health Recheck Enabled/Disabled
- 2 Set Retry Limit
- 3 Sold Out Enable Enabled/Disabled
- 4 Not Used
- 5 Sensor Override Enabled/Disabled
- 6 Interval Clearing Is On/Is Off
- 7 Set Lights Off
- 8 Set Refrigeration Temp
- 9 Set Storage Time
- 0 Set Storage Temp

Note: all items in *Italics* under SETUP MODES require password entry for access if one has been assigned.

**FACTORY DEFAULT REQUIRES NO PASSWORD UNTIL NEW PASSWORD OTHER THAN 0000 IS ENTERED.**

Menu items shown above reflect software revision 804,917,93x.x1 and higher

Service Mode	Pages 14 through 15
Test Mode	Pages 16 through 18
Setup Mode	Pages 19 through 20
Setup Mode 2	Pages 21 through 22

# PROGRAMMING

## SERVICE MODE MENU ITEMS

### SERVICE MODE

Enter SERVICE MODE by opening the service door and pressing the Service button once. The display will read "SERVICE MODE". The following choices are now available:

**NEXT ITEM** - Press key "A"

**CASH BOX** - Press key "B"

Shows the amount inserted into the bill validator and the change diverted to the cash box from the coin mechanism since the last CLEAR TOTALS or MASTER RESET. To view the cash box totals, press the letter "B" on the keypad and the display will scroll "CASH BOX", then display #.##.

Press the "CLR" key to return to "SERVICE MODE" or press the "A" key to advance to the next menu item below.

**SALES** - Press key "C"

Shows total sales since last CLEAR TOTALS or MASTER RESET. This total includes change not diverted to the cash box and still being held in coin mechanism escrow tubes. To view the total sales press the letter "C" on the keypad and the display will scroll "SALES", then display #.##.

Press the "CLR" key to return to "SERVICE MODE" or press the "A" key to advance to the next menu item below.

**DISPLAY TEMP (if temperature sensor hardware kit is installed)** - Press key "D"

Shows the cabinet temperature in degrees Celsius or degrees Fahrenheit. Press the letter "D" on the keypad. The display will scroll "Display Temperature". Pressing the letter "C" on the keypad will display the temperature in degrees Celsius. Pressing the letter "F" on the keypad will display temperatures in degrees Fahrenheit. If no sensor is installed, "TEMP SEN" will appear on the display. NOTE: THIS SETTING DOES NOT CHANGE THE APPEARANCE OF THE DIGITAL DISPLAY IN THE STANDBY OR OPERATION MODE.

Press the "CLR" key to return to "SERVICE MODE" or press the "A" key to advance to the next menu item below.

**NOT USED** - Key "E"

**CLEAR TOTALS** - Press key "F"

Allows the service technician to clear totals in CASH BOX, SALES, NUMBER SOLD, DOOR OPENINGS, POWER OUTAGES, and SALES BY COLUMN. Press the letter "F" on the keypad and the display will scroll "CLEAR TOTALS". Press the "\*" key, the display will read OK momentarily and an audible tone will be heard. The totals are cleared and the display returns to "SERVICE MODE".

**NUMBER SOLD** - Press key "1"

Shows the total number of items sold since the last CLEAR TOTALS OR MASTER RESET. Press the number "1" on the keypad and the display will scroll "NUMBER SOLD", then change to ##.

Press the "CLR" key to return to "SERVICE MODE" or press the "A" key to advance to the next menu item below.

**ENABLE ITEM** - Press key "2"

Allows an individual selection, a complete tray, or the entire machine to be enabled or disabled. This is most commonly used when a selection is out of order and you are awaiting parts and do not want the customer to utilize that selection. Press the number "2" on the keypad and the display will scroll "ENABLE ITEM". Press the "\*" key and the display will read "ITEM". There are now three choices:

1. Pressing the "\*" key will toggle between enabled and disabled for the entire machine, the display will show the new state i.e. enabled or disabled.
2. Pressing a tray selection followed by "\*" will show the new state of that tray. (For example, pressing "A\*" will show the new state for the A tray. Pressing "A\*" again will toggle the state.)
3. Pressing an item selection will show the current state of that item; for example, pressing "A1" will show the new state of that item, pressing "A1" again will toggle the state.

After making any of the above selections, an audible tone will be heard and the display will read OK momentarily.

If a selection has been disabled in this mode and the customer tries to purchase from the programmed selection(s), the vender will display "SELECT ANOTHER ITEM".

Press the "CLR" key to return to "SERVICE MODE".

# PROGRAMMING

## **SALES BY COLUMN - Press key "3"**

Shows the total number sold from each selection since the last CLEAR TOTALS or MASTER RESET. Press the number "3" on the keypad and the display will scroll "SALES BY COLUMN". Press the "\*" key and the display will read "ITEM". Select the item to be checked (the total number sold from that selection will be on the right side of the display and the item number will be on the left side of the display). Press the "CLR" key to return to service mode.

## **ESCROW - Press key "4"**

Allows a bill to be returned if the change return lever is pressed before a selection is made. Factory setting is ESCROW N.

Press the number "4" on the keypad and the display will read "ESCROW Y" or "ESCROW N", depending on the current state. Pressing the "\*" key toggle the vender from ESCROW Y to ESCROW N. Example: If "ESCROW Y" is showing on the display, pressing the "\*" key will disable the escrow function and the display will read ESCROW N.

This feature only affects those machines with a bill validator installed. Press the "CLR" key to return to "SERVICE MODE".

## **FORCE VEND - Press key "5"**

Forces the customer to make a vend by inhibiting the coin return lever once the minimum vend price line has been met or exceeded. The coin return lever will not be inhibited if there is not enough credit to vend the lowest priced item or if a vend failure has occurred. Factory setting is "FORCE N".

Press the number "5" on the keypad the display will read "FORCE Y" or "FORCE N", depending on the current state. Pressing the "\*" key will toggle the state. Press the "CLR" key to return to "SERVICE MODE".

## **AUDIO FEEDBACK ENABLED/DISABLED - Press key "6"**

Allows an audible tone to be turned on and off. If enabled, an audible tone is heard when keys are pressed when making a selection and when programming the vender.

Press the number "6" on the keypad and the display will scroll "ENABLE AUDIO FEEDBACK" or "DISABLE AUDIO FEEDBACK". The factory setting is disabled. Press the "\*" key with the setting you wish to use showing on the display. An audible tone will be heard and the display will change to "OK", then return to Service mode.

## **SET REGULAR PRICES - Press key "7"**

Allows the setting of regular prices for an individual item, a complete tray, or the entire machine. Factory setting is \$99.95.

Press the number "7" on the keypad and the display will scroll "SET REGULAR PRICES". Press the "\*" key and "\$00.00" will be displayed. Prices are entered using the numbers on the keypad and will shift in from the right as numbers are pressed. Once the desired price is showing on the display, use one or all of the options listed below for setting the price to the desired selection:

1. **All selections.** Press the \* key after entering desired price and all selections in the vender will now be set
2. **One tray.** Pressing the letter of the shelf followed by the \* key will price that shelf to a single price. For example, to price the A shelf for \$1.25, first dial in the price then choose A followed by \*.
3. **Single selection.** Press the desired selection number or numbers corresponding to the selections that require changing.

Priority will be given to the higher ranked method. For example, If one price on the A tray was set to \$1.50 using option 3 above and you wish to change the remaining selections on that tray using option 2, the pricing for the entire tray would take precedence. Conversely, if the price was set using option 2 first followed by the single selection using option 3, the pricing for the remainder of the shelf would remain and the new price for the single selection would change to the new value.

Press the "CLR" key to return to "SERVICE MODE".

## **NOT USED - Key "8"**

## **RELAY TOGGLE TEST - Press key "9"**

Allows the service technician to test the relay electronic control of the compressor (C), evaporator fan (F), and lights (L). Press the number "9" key on the keypad and the display will scroll "RLY TOGL" briefly and then "CO FO LO" will appear. Pressing number "1" on the key pad will toggle the relay on (C1) or off (C0). CAUTION: Disconnect the power supply to the compressor before testing the compressor relay. Failure to disconnect the relay may result in damaging the compressor. Pressing number "2" on the keypad will toggle the evaporator fan on (F0) or off (F1). Pressing number "3" on the keypad will toggle the lights on (L0) or off (L1). Press "CLR" to return to "Service Mode".

## **CLEAR ERRORS - Press key "0"**

Allows the service technician to clear any recorded errors. Press the number "0" on the keypad and the display will scroll "CLEAR ERRORS". Press the "\*" key and the display will read "OK" momentarily and an audible tone will be heard. The errors are cleared and the display returns to "SERVICE MODE".

# PROGRAMMING

## TEST MODE

Enter TEST MODE by opening the service door and pressing the blue Service button twice. The display will read "TEST MODE".

**NEXT ITEM** - Press key "A"

**LIST ERRORS** - Press key "B"

Allows the service technician to view a list of all recorded errors. Press the letter "B" on the keypad and the display will scroll "LIST ERRORS", then change to "NO ERROR" if no errors exist or, if errors are present, one of the error prompts below will be displayed. If an error code is displayed, press the "\*" key to view the next error until "END LIST" is displayed. With "END LIST" showing on the display, press the "CLR" key to clear errors. When the "CLR" key is pressed, an audible tone will be heard and the display will change momentarily to "OK" then back to TEST MODE. If you wish to exit the list without clearing errors, simply push the "\*" key and the display will return to list errors. If the CLR key is pressed prior to reaching the end of the list, the display will jump to END LIST.

Explanations for the error codes are listed below. Note: The prompts listed will only show on the display if an error has occurred.

**NO ERROR** No errors have occurred.

**COIN ERR** Indicates a fault message from the coin mechanism.

**BILL ERR** Indicates a fault message from the bill validator.

**CARD ERR** Indicates a fault message from the card reader.

**MDB ERR** Indicates a communication error between the control board and peripherals.

**MEM ERR** Indicates a problem with the program memory or associated components. This is a fatal error and will shutdown the machine. This error will usually occur if the battery on the controller is in need of replacement or if a "MASTER RESET" occurred due to changing the controller EPROM or by manually doing a MASTER RESET. After clearing this error, the vender will have to be reprogrammed, as all options will have been reset.

**VEND ERR** Indicates one or more channels/solenoids are out of service. When the display reads "VEND ERR", press the "A" key and the first channel/solenoid with a problem will be displayed. Continue pressing the "A" key to display additional vend errors (if any) until the display returns to "VEND ERR". NOTE: IF THIS ERROR IS SHOWN, ALL PROBLEMS MUST BE REPAIRED AND A "SELF TEST" (see below) MUST BE PERFORMED IN ORDER TO RETURN THE LISTED CHANNEL/SOLENOID TO SERVICE.

**PWR OUT** Indicates an interruption of the power to the controller board. When the display reads PWR OUT, press the "A" key and the date and time of the last power interruption will be displayed. Continue pressing the "A" key and the display will show the time and date of the last 5 power outages, starting with the most recent.

**LOW 28V** Indicates a problem with the controller board's 28 Volt power supply. This is a fatal error and will put the vender out of service until resolved.

**ROW a ERR** The a represents the letter of the row drive that failed (A-F ie. ROWBERR) and gives the indication that the B row failed during the last test firing. This error will only occur while performing the "SELF TEST" (see explanation below) and the controller board has encountered a short or a very high current condition.

**COLnERR** The n indicates the number of a column driver (1-9, i.e. COL1ERR). This error is displayed if the controller has detected a short or a very high current condition during the last test firing.

This is a fatal error and will put the vender out of service until resolved.

**OVER CUR** Indicates an over current condition has occurred (i.e. a shorted component or a low power condition). This error is serious. If it reoccurs after CLEAR ERRORS, further troubleshooting will be required.

**TEMP SEN** Indicates a temperature sensor failure while health control is enabled.

**HEALTH T** Indicates the temperature in the vender did not reach 45 degrees F within 30 minutes after the door was closed.

**\*HEALTH"C** Indicates the temperature in the vender went above 45 degrees F since the last door closure or remained above 41 degrees F for longer than 15 minutes.

**NO KEYPAD** Indicates a failure of the keypad or associated cable (will show on display on power up and stay there until problem is resolved).

**BAD RAM** Indicates a problem with the control board.

**END LIST** Indicates you have scrolled through the list of all present errors. Press the "CLR" key and display will change to "OK", an audible tone will be heard and the display will change to "NO ERRORS". Press the "CLR" key to return to "TEST MODE", or the "A" key to proceed to "SELF TEST"



# PROGRAMMING

## **SELF TEST - Press key "C"**

Allows the service technician to run a quick diagnostics of all solenoids and their associated harnesses and control board drivers.

Press the letter "C" on the keypad and the display will scroll "SELF TEST". Press the "\*" key and the display will change to "TESTING" as the controller sends a low current pulse to each of the solenoids. The display will then change to "ERRS ##". Normal error indications are based on the machine's configuration. The normal indication for a 5 tray vender is "ERRS 9". The display will then change to "SELF TEST". The service technician should list errors (item B in test mode) after Self Test. Press the "CLR" key to return to "TEST MODE" or the "A" key to proceed to "DISPLAY TEST".

## **DISPLAY TEST - Press key "D"**

Allows the service technician to check all segments of the LED display unit. Press the letter "D" on the keypad and the display will scroll "DISPLAY TEST". Press and hold the "\*" key and the display will alternate between all \*'s and all "0." with decimal points. Releasing the "\*" key will return to "TEST MODE".

## **KEYPAD TEST - Press key "E"**

Allows the service technician to test any or all keypad keys. Press the letter "E" on the keypad and the display will scroll "KEYPAD TEST". Press the "\*" key and the display will go blank, and then press each key on the keypad. After each entry the characters will shift into the display from right to left until the "CLR" key is pressed. The display will return to "TEST MODE".

## **AUTO SEQUENCE - Press key "F"**

Allows the service technician to put the machine into automatic vend. An item will be vended every second, starting from A1 and running through the ninth selection on the bottom tray of the machine, then repeating until the service technician stops it by pressing the "CLR" key. Press the letter "F" on the keypad and the display will scroll "AUTO SEQUENCE". Press the "\*" key, automatic vend will start and the display will show selection currently being tested. Press the "CLR" key to stop and return to "TEST MODE".

**CAUTION:** It is strongly recommended this feature only be used to check channels/solenoids on empty machines.

## **TUBE FILL/DISPENSE - Press key "1"**

Allows the service technician to inventory currency in the coin mechanism escrow tubes and "Teach" the controller how many coins of each denomination are in that inventory. This allows for the maximum number of dollar bills to be accepted prior to enabling the "USE EXACT CHANGE" function. This also provides for exact cash accountability in the audit functions. This function can also be used as a diagnostic tool to insure the coin mechanism is responding properly. Press the number "1" on the keypad and the display will read "TUBEFILL/DISPENSE". Press the "\*" key and the display will show the lowest denomination accepted and the number of these coins inventoried (i.e. \$.05 - 6). Press the letter "A" on the keypad to scroll through the denominations available. With a given denomination displayed (i.e. \$.05 - 6), an inserted coin of this denomination via the coin chute will increase the inventory shown. Press the "\*" key and the denomination displayed will be dispensed to the coin return cup and the inventory will be decreased. Note: When you insert any denomination the display will change to show the denomination inserted.

## **DAYLIGHT SAVINGS TIME - Press key "2"**

Allows the service technician to enable daylight savings time to be set as it applies to the selected Daylight Savings Rules Setting. Press the "\*" key to show the current DST setting. Press the "A" key to scroll through the different DST settings that are available. With the setting you wish to use showing on the display, press the "\*" key.

- DST OFF – No Daylight Savings Time
- DST AMER - American Rules. If enabled, the VCU will set the clock back one hour on the last Sunday of October (2:00 AM), set the clock ahead one hour on the first Sunday in April (2:00 AM).
- DST EURO – European Rules. If enabled, the VCU will set the clock back one hour on the last Sunday of October (1:00 AM), set the clock ahead one hour on the last Sunday in March (1:00 AM).
- DST AUS – Australian Rules. If enabled, the VCU will set the clock back one hour on the last Sunday of March (1:00 AM), set the clock ahead one hour on the first Sunday in October (1:00 AM).

# PROGRAMMING

## **SET NOT AVAILABLE MODE - Press key "3"**

This setting works in conjunction with the "SET NOT AVAILABLE TIME" (option 3 in setup mode). This setting must be showing "Cancel N" in order for the Not Available times to function as programmed. This mode can also be used to manually disable the times established in "SET NOT AVAILABLE TIME" mode as long as the function is set to "CANCEL Y" before the "SET NOT AVAILABLE TIME" starts. Press the number "3" on the keypad and the display will scroll "SET NOT AVAILABLE MODE" and then change to "CANCEL Y" or "CANCEL N", depending on the current state. Factory default for this setting is "CANCEL N" Pressing the "\*" key will toggle the state and set the controller to the new condition shown on the display (pushing the \* key with CANCEL Y on the display will ALLOW the not available mode to function as programmed). Press the "CLR" key to return to "TEST MODE".

## **SET CREDIT TIMER MODE - Press key "4"**

Allows the service technician to set the vender to cancel a credit or keep a credit showing on the display after 5 minutes. Press the number "4" on the keypad and the display will scroll 'SET CREDIT TIMER MODE' once, then the display will read "CANCEL Y" or "CANCEL N" depending on the current state. Pressing the "\*" key will toggle the state. "CANCEL N" will save a credit indefinitely. "CANCEL Y" will only save a credit for five minutes. Press the "CLR" key to return to "TEST MODE".

## **DOOR OPEN - Press key "5"**

Shows number of times the service door has been opened since last "CLEAR TOTALS" or "MASTER RESET". Press the number "5" on the keypad and "DOOR OPEN" will scroll across the display and then change to a #, which is the number of times the service door has been opened since the last "CLEAR TOTALS" or "MASTER RESET". Use the "\*" key to view the day, date, and time of the last opening. Press the "A" key to scroll through the last 5 openings. Press the "CLR" key to return to "TEST MODE".

## **POWER OUT - Press key "6"**

Shows the number of times the machine has lost power since last "CLEAR TOTALS" or "MASTER RESET". (This is a power outage for any reason including the machine being unplugged or the machine's master power switch being turned off). Press the number "6" on the keypad and "POWER OUT" will scroll across the display, then the display will show a #, which is the number of times power has been lost to the control board since the last "CLEAR TOTALS" or "MASTER RESET". Use the "\*" key to view the day, date, and time of the most recent power outage. Once the date is showing on

the display, press the "A" key to scroll through the last five outages. Press the "CLR" key to return to "TEST MODE".

## **TEST HEALTH GUARD - Press key "7"**

This setting is in place to test the functioning of the health guard system by simulating a Health Code Error. Once activated, any selections programmed in "ENABLE HEALTH CONTROL" in the setup mode will be disabled. To test health guard, press the number 6 on the keypad and the display will scroll "TEST HEALTH GUARD". Push the "\*" key and the display will change to OK and an audible tone will be heard and the display will return to "TEST MODE". Within one minute of returning the vender to service, items that were set in "ENABLE HEALTH CONTROL" setting in the SETUP MODE will be put out of service. Additionally, a "HEALTH G" error will be displayed in 'LIST ERRORS. Errors must be cleared before programmed items can be returned to service. Note: A Temperature Sensor must be installed for this function to work.

## **DISPLAY HEALTH GUARD - Press key "8"**

Allows the service technician to view the selections that are listed under the "ENABLE HEALTH CONTROL" in the SETUP MODE. Press the number "8" on the keypad and the display will read "DISPLAY HEALTH GUARD". Press and hold the "\*" key and the selection(s) that are listed under the health control will be displayed or "END LIST" if no selections are listed. Releasing the "\*" key will return to "DISPLAY HEALTH GUARD".

## **TEST VEND - Press key "9"**

Allows the service technician to test vend any item. Press the number "9" on the keypad and the display will read "TEST VEND". Press the "\*" key and the display will read "ITEM". Select the item/column to be tested by pressing the corresponding keys on the keypad (i.e. A6) and the corresponding solenoid will cycle. Ensure that the glass door is closed if utilizing this function when product is loaded in vender. Press the "CLR" key to return to "SERVICE MODE".

## **CLEAR ERRORS - Press key "0"**

Allows the service technician to clear any recorded errors. Press the number "0" on the keypad and the display will scroll "CLEAR ERRORS". Press the "\*" key and the display will read "OK" momentarily and an audible tone will be heard. The errors are cleared and the display returns to "SERVICE MODE".

# PROGRAMMING

## SETUP MODE

Enter SETUP MODE by opening service door and pressing the Service button three times. The display will read "SETUP MODE".

NOTE: Several areas in the SETUP MODE are password protected. When entry into one of these areas is attempted the display will read "PW" if a password has been entered in the SETUP MODE. The password must be entered at this point before the service technician is allowed to proceed. The password need only be entered once during a service call provided the service door is not closed. If the door is closed and then re-opened, the password must be entered again before accessing a protected area. The factory default password is 0000. If the password is set at 0000 you will not be required to enter a password to access password protected modes. The display will show \*'s as the password is entered. When the last character is entered, the display will read "OK", and then will shift into the requested area. If the display reads "BAD" after the last character is entered this means the password was not accepted.

**NEXT ITEM** - Press key "A"

**NOT USED** - Key "B"

**NOT USED** - Key "C"

**ENABLE DOLLAR SIGN** - Press key "D"

(PASSWORD REQUIRED)

Allows the service technician to remove the dollar sign (\$) from the display when a product price, customer credit, or change due is displayed. When enabled, the dollar sign will appear in the display; when disabled it will not appear. Press the letter "D" on the keypad; the display will scroll "ENABLE DOLLAR SIGN" or "DISABLE DOLLAR SIGN". Pressing the "\*" key will enable the state shown on the display, i.e. if the dollar sign is desired, and the display is reading "ENABLE DOLLAR SIGN", push the "\*" key to enable dollar sign. Once the "\*" key is pressed, the display will change to "OK" and an audible tone will be heard. The display will then change to "SETUP MODE". To return to "SETUP MODE" without changing state, press the "CLR" key.

**NOT USED** - Key "E"

**MASTER RESET** - Press key "F"

(PASSWORD REQUIRED)

Allows the service technician to restore factory defaults to the machine or reset the Controller Board's memory after reconfiguring a tray or installing a new EPROM. Since this feature resets resettable sales data, care should be taken prior to using. Press the letter "F" on the keypad and

"MASTER RESET" will scroll across the display. Press the "\*" key and the display will read "OK" momentarily and audible tones will be heard. The display will then return to the idle message. Please see table on next page for programming options effected by MASTER RESET. NOTE: A power out error message will be generated when a master reset is performed, however, the time and date will not be listed with it.

The table outlines the results of using MASTER RESET.

ITEM	RESET TO
CASH BOX	\$0.00
SALES	\$0.00
NUMBER SOLD	0
SALES PER COLUMN	0
ESCROW	ESCROW N
FORCE	FORCE N
AUDIO FEEDBACK	DISABLED
SET REGULAR PRICES	99.95
LIST ERRORS	Pwr Out
TUBE FILL/DISPENSE	CLEARED
DAYLIGHT SAVINGS	DISABLED
NOT AVAILABLE	CANCEL N
CREDIT TIMER	CANCEL N
DOOR OPEN	0
POWER OUT	0
DISPLAY HEALTH GUARD	GUARD
ENABLE DOLLAR SIGN	ENABLED
NOT AVAILABLE TIME	CLEARED
DISPLAY RESET	DISABLED
HEALTH CONTROL	DISABLED
DROP SENSOR	DISABLED
PASSWORD	0000
STS ENABLE	DISABLED
CUSTOM STS	CLEARED
VEND LIMIT	0
HEALTH RECHECK	DISABLED
RETRY LIMIT	DISABLED
SOLD OUT	ENABLED

**SNACK SHELF SET UP** - Press key "1"

(PASSWORD REQUIRED)

Not available at print. To be developed at a later date.

**NOT USED** - Key "2"

**SET NOT AVAILABLE TIME** - Press key "3"

(PASSWORD REQUIRED)

Password protected. Before entering or changing this setting you must enter the password if one has been assigned. This mode allows up to 4 different time periods that use of the machine may be restricted. Refer to Initial Set Up section Set Not Available Times.

# PROGRAMMING

## DISPLAY RESET - Press key "4"

(PASSWORD REQUIRED)

This feature is used to allow the service technician the ability to set the control board to work with an IR capable Display Board or a non-IR capable Display Board. Press the number "4" on the keypad; the display will scroll "ENABLE DISPLAY RESET" or "DISABLE DISPLAY RESET". Pressing the "\*" key will enable the state shown on the display. Once the "\*" key is pressed, the display will change to "OK" and an audible tone will be heard. The display will then change to "SETUP MODE". To return to "SETUP MODE" without changing state, press the "CLR" key.

## DATE/TIME - Press key "5"

Shows the day, date, and time setting currently in the system in following format: SUN 01/02/00 1330 Press the number "5" on the keypad, "DATE/TIME" will scroll once, then the day, date, and time will scroll across the display. Setting the day, date, and time is covered in detail in the INITIAL PROGRAMMING section of this manual. Press the "CLR" key to return to "SETUP MODE".

## TOTAL SALES - Press key "6"

Shows total sales since machine manufacture or last MAS-TER RESET. This total is not cleared by CLEAR TOTALS. Press the number "6" on the keypad, the display will scroll "TOTAL SALES" then change to \$#.##. Press the "CLR" key to return to "SETUP MODE".

## ENABLE HEALTH CONTROL - Press key "7"

Allows the service technician to select items to ENABLE HEALTH CONTROL. When enabled, if the temperature in the vender does not reach 45 degrees F within 30 minutes after the service door is closed, a "HEALTH TIME" error will occur and lockout the enabled selection(s) from vending until after the error is cleared. Also, if the temperature in the vender goes above 41 degrees F for more than 15 minutes after the initial cool down period, a "HEALTH CONTROL" error will occur and lockout the enabled selection(s) from vending until the error is cleared. Press the number "7" on the keypad and the display will scroll "ENABLE HEALTH CONTROL". Press the "\*" key and the display will show 'ITEM'. There are now three choices:

1. **All selections.** Press the \* key and all selections in the vender will now be set for health control. The display will change to "ENABLED" then back to "ITEM".
2. **One tray.** Pressing the letter of the shelf followed by the \* key will set control for all selections on that shelf. For example, to control the A shelf push key "A" followed by "\*" key. The display will change to "ENABLED" then back to "ITEM".

3. **Single selection.** Press the desired selection number or numbers corresponding to the selections that require the health control function. After each selection is made the display will change to "ENABLED" then back to "ITEM".

Press the keypad buttons again and the display will flash "DISABLED" and return to "ITEM". Priority will be given to the higher ranked method If one selection on the A tray was set to ENABLE using option 3 above and you wish to change the remaining selections on that tray using option 2, the Setting for the entire tray would take precedence. Conversely, if the tray was set using option 2 first followed by the single selection using option 3, the setting for the remainder of the shelf would remain and the new price for the single selection would change to the new value. Press "CLR" to return to "SETUP MODE".

## DROP SENSOR ENABLED/DISABLED - Press key "8"

(PASSWORD REQUIRED)

Allows Enabling or Disabling of drop sensor Credit Guard function. When enabled, the customer will retain credit for the amount deposited if a product does not pass through the sensor beam in the recovery unit. This state will allow three attempts to vend a product before credit is lost. Both states will prevent a vend if a product is in the recovery unit. Press the number "8" on the keypad and "ENABLE DROP SENSOR" or "DISABLE DROP SENSOR" will scroll across the display. Pressing the "\*" key will switch the state. Press the "CLR" key to return to "SETUP MODE".

## NOT USED - Key "9"

## ENTER NEW PASSWORD - Press key "0"

(PASSWORD REQUIRED)

Allows the service technician to enter a personalized password. IF YOU DECIDE TO CHANGE FROM THE DEFAULT PASSWORD, PLEASE ENTER THE NEW PASSWORD SLOWLY AND CAREFULLY!!! Press the number "0" on the keypad and "ENTER PASSWORD" will scroll across the display. Press the "\*" key and the display will read "PW". Enter the password, the display will read "OK" momentarily then "NEW PW" will be displayed. Enter the new password. After the fourth character of the new Password is entered the display will read "OK" momentarily and return to "SETUP MODE".

# PROGRAMMING

## SETUP MODE 2

Enter SETUP MODE 2 by opening the main door and pushing the Service button four times. The display will read "SETUP MODE 2"

**NEXT ITEM** - Press key "A"

**SPACE TO SALES ENABLE/DISABLE** - Press key "B"

Allows enabling or disabling the Space-to-Sales vend mode. When Enabled, Space-to-Sales vends are performed according to the configurations defined using "DEFAULT STS CONFIG" and/or "CUSTOM STS CONFIG".

Press the Letter "B" on the keypad. The display will scroll the current state of the Space-to Sales vend mode as "STS ENABLED" OR "STS DISABLED". There are now two choices:

1. Press the "CLR" key to leave the Space-to-Sales vend mode unchanged and return to "SETUP MODE 2"
2. Press the "\*" key to toggle the state. The display will scroll a new message indicating the updated state.

**CUSTOM STS CONFIG** - Press key "C"

Configures the Space-to-Sales according to user input.

Press the letter "C" on the keypad. The display will read "START". There are now 3 choices:

1. Pressing the "\*" key will set STS to a one to one configuration such that each selection is mapped only to it's corresponding column.

**Note: This setting overrides any previously defined Space-to-Sales blocks.**

2. Pressing a tray selection followed by "\*" will configure an entire tray as a single Space-to-Sales block. Example is selections A1 through A9 vend from columns A1 through A9 sequentially.
3. Pressing an item selection (A1) will specify the first product of the Space-to-Sales block. After the first item is programmed, the display will change to "END". Press the item selection corresponding to the last item in the block. This option may transcend more than one shelf, i.e. A1 to B9. Important Note: Any column number ending in the number "0" (ie A0, B0, C0, D0, E0) is not included in STS blocks. Example: A1 through B6 will not include A0. Also, if you use any column "0" for the end of a STS block, it will include all shelves and columns below it as the "0" columns are tied to the F tray port on the control board. Example: STS block A1 through B0 will actually include A1 through E0, but does not include A0.

In all of the above options, after a selection is made, an audible tone will be heard and the display will change briefly to "OK" then back to "START". Press "CLR" at any time to return to SETUP MODE 2.

**DEFAULT STS CONFIG** - Press key "D"

Configures the Space-to-Sales to the preset mappings.

Press "D" on the keypad and the display will scroll "DEFAULT STS CONFIG". Press the "\*" key to configure Space-to-Sales in preset blocks of three (A1 – A3, A4-A6, A7-A9, B1-B3,...).

**DISPLAY STS CONFIG** - Press key "E"

Allows verification of the Space-to-Sales settings for an individual item.

Press the letter "E" on the keypad. The display will scroll "DISPLAY STS CONFIG". Press the "\*" key and the display will change to "ITEM". Enter any selection item and the display will read "##-## ##". The first ## indicates the first column in the selection's block. The second ## indicates the last column in the selection's block. The last ## indicates the column that the next vend will come from in this Space-to-Sales block. For example, entering "A2" might display "A1-A3 A1", indicating that selection A2 is part of the block that spans between A1 and A3 and that A1 selection is next in line to be vended.

**NOT USED** - Key "F"

**HEALTH RECHECK ENABLED/DISABLED** - Press key "1"

When enabled, after a "HEALTH TIME" error has occurred, the vender will recheck the cooler compartment temperature 3 times in 15-minute intervals. If the temperature drops below 41 degrees, the "HEALTH TIME" error is cleared and selections are re-enabled. If any recheck reads above a previous reading, or if the temperature is not below 41 degrees by the third recheck, the "HEALTH TIME" error will remain and selections will continue to be blocked.

Press the number "1" key. The display will scroll "HEALTH RECHECK ENABLED" or "HEALTH RECHECK DISABLED". There are now 2 choices:

1. Press the "CLR" key to leave the Health Recheck setting unchanged and return to "SETUP MODE 2"
2. Press the "\*" key to toggle the state. The display will scroll a new message indicating the updated state.

# PROGRAMMING



This setting is inconsistent with NAMA guidelines for health-controlled venders.

## **SET RETRY LIMIT - Press key "2"**

This function provides the customer with an additional opportunity (opportunities) to make a selection after a failed vend. When a retry limit is set, credit remains on the vender and the customer may make additional selections until the retry limit is reached at which point credit is returned.

Press the number "2" key. The display will scroll "SET RETRY LIMIT". Then the display will read "LIMIT #". The value # is the current retry limit which is used after an initial failed vend. This means that a retry limit of 3 will allow the user a total of 4 selections: the initial selection plus 3 retries. After the limit is reached, credit is returned.

## **SOLD OUT ENABLED/DISABLED - Press key "3"**

Controls sold out detection by the drop sensor. When enabled, a signal is sent to the VCU when the drop sensor does not detect a selected item. That signal tells the VCU that the item selected is sold out and removes it from the STS block until the next time the vender is serviced.

Press the number "3" on the keypad. The display will scroll "SOLD OUT ENABLED" or "SOLD OUT DISABLED". Press the "\*" key to toggle the state to the desired setting or press "CLR" to exit without making changes and return to "SETUP MODE 2"

## **NOT USED - Key "4"**

## **SENSOR OVERRIDE ENABLED/DISABLED – Press key "5"**

This should only be used under the direction of Dixie-Narco Technical Service. Press key 5 and the display will scroll "SENSOR OVERRIDE ENABLED or DISABLED" depending on current state. Press the "\*" key to toggle the state of the setting. With the display showing the state you wish to use press the "CLR" key to exit. When enabled the controller will temporarily ignore the vend sensors that may become blocked from condensation immediately after the vender as been filled. The controller will ignore the vend sensor for up to 3 minutes from the time the service door is closed. If the sensor remains clear continuously for 30 seconds the controller will return to normal operation. During the override period, any vends performed will be treated as successful vends regardless of the Drop Sensor setting, except in the case of a solenoid error. Note that after 3 minutes, a blocked sensor will effectively prevent any new vends from being started.

## **INTERVAL CLEARING IS ON/IS OFF – Press key "6"**

This function is used to indicate the state of the interval clearing setting. Press the number "6" key and "INTERVAL CLEARING IS ON or OFF" will scroll across display depending on the current setting. When "ON", the interval (resettable) data to automatically be cleared upon successful completion of a DEX audit. When "OFF" it allows for remote auditing devices that clear resettable data manually to be used to clear the data. Press the "\*" key to accept the displayed setting, press the "CLR" key to exit the menu.

## **SET LIGHTS OFF – Press key "7"**

The function is used to set the Date and Day when Lights will be turned OFF. Press the number "7" key and "SET LIGHTS OFF" will scroll across display. Press the "\*" Key. "START TIME" will display, then "HOUR 00" will display. Use the Keypad enter time then press "\*" key. "MIN 00" will display. Use the Keypad enter time then press "\*" key. "SUN N" will display. Use the "A" key to toggle "N" for No or "Y" for Yes. Press the "\*" Key, the next day will appear. Repeat for all days. Press "CLR" to exit.

## **SET REFRIGERATION TEMP – Press key "8"**

This function is used to set product Temperature. Press the number "8" key and "SET REFRIGERATION TEMP" will scroll across display then "DEG F 35" will display. Use the keypad to enter the Temperature setting in degrees F. Press the "\*" key to accept. "OK" will appear briefly. Press the "CLR" key to exit.

## **SET STORAGE TIME – Press key "9"**

This function is used set the Date and Day when Storage Temperature will be ON. Press the number "9" and "SET STORAGE TEMP" will scroll across display. Press the "\*" Key and "START TIME" will display, then "HOUR 00" will display. Use the Keypad to enter time then press "\*" key. "MIN 00" will display. Use the Keypad enter time then press "\*" key. "MIN 00" will display. Use the Keypad enter time then press "\*" key. "SUN N" will display. Use the "A" key to toggle "N" for No or "Y" for Yes. Press the "\*" Key, the next day will appear. Repeat for all days. Press "CLR" to exit.

## **SET STORAGE TEMP – Press key "0"**

This function is used to set Storage Temperature. Press the number "0" key and "SET STORAGE TEMP" will scroll across display then "DEG F 65" will display. Use the keypad to enter the Temperature setting in degrees F. Press the "\*" key to accept. "OK" will appear briefly. Press the "CLR" key to exit.

# GENERAL MAINTENANCE

The most important facets of proper care and maintenance of your machine are the electrical power supplied to it, leveling, and cleanliness of the machine.

## **POWER**

The machine must be connected to a dedicated 120 VAC, 15 Amp circuit (U.S. and Canada).

---

### *CAUTION:*

*REMOVE POWER TO THE AC DISTRIBUTION BOX WHEN ANY ELECTRICAL COMPONENTS ARE CONNECTED / DISCONNECTED FOR TESTING OR REPLACEMENT.*

---

## **CLEANING**

*DO NOT USE A WATER JET OR NOZZLE TO CLEAN THE VENDER*

---

## **GLASS DOOR**

The display glass should be cleaned inside and out with paper towels and glass or non-abrasive all-purpose cleaner. The gasket around the product door should be wiped down using warm water, any mild general purpose, non-abrasive cleaner and a soft towel. Never lubricate the gasket and always check for cracking or deformities which may cause leaks. Replace if necessary.

## **TRAYS / TRAY INSERTS**

The trays and tray inserts should be cleaned periodically using warm water and a mild general purpose, non-abrasive cleaner. Care should be taken to ensure water does not enter the solenoids. **DO NOT USE SOLVENTS OR ABRASIVE MATERIALS TO CLEAN ANY PORTION OF THE TRAY.**

## **SLIDE/PUSHER ASSEMBLY**

The slide/pusher assembly should be cleaned periodically using warm water and any mild general-purpose non-abrasive cleaner. After drying, the slide assembly needs to have a coat of Armorall applied. Care should be taken to ensure liquid does not enter solenoids. **DO NOT USE SOLVENTS OR ABRASIVE MATERIALS TO CLEAN ANY PORTION OF THE TRAY.**

## **CABINET**

Wash the cabinet with a good detergent or soap mixed in warm water. Wax the vender often with a good grade of automobile wax. Any corrosion inside the vender should be removed with fine steel wool and the area should be painted with white paint.

Repair any scratches on painted surfaces to prevent corrosion.

## **RECOVERY UNIT**

Cleaning of the product delivery bin and condenser area requires removal of the product delivery bin.

To remove:

Open the service door.

Open the product door.

Pull the bin straight out until clear of the machine and set aside.

When installing, make sure the recovery unit is pushed all the way back before closing the product and service doors.

## **DRAIN PAN**

Check the drain pan periodically for dirt, debris, and proper alignment. Clean as needed. Ensure nothing obstructs the drain tube and drain hose.

---

## **WARNING**

**THE COMPRESSOR ELECTRICAL CIRCUIT IS ALWAYS LIVE WHEN THE PLUG IS CONNECTED TO AN ELECTRICAL OUTLET.**

---

## **REFRIGERATION CONDENSER**

Clean the condenser periodically of dirt or lint build-up. Remove the build up with a brush or vacuum, or blow the dirt out of the condenser with compressed air and approved safety nozzle. Ensure nothing obstructs air intake at the bottom of the main door. Ensure nothing obstructs air exhaust at the rear of the cabinet.

## **COIN ACCEPTOR**

Follow the Coin Acceptor Manufacturer's instructions.

## **LUBRICATING THE VENDER**

The vender refrigeration system does not require any field lubrication. The hermetic refrigeration system and fan motors are manufactured with lifetime lubrication.

# GENERAL MAINTENANCE

## EPROM REPLACEMENT

Software changes / upgrades are accomplished by changing the EPROM on the Control Board.  
Remove power to the AC Distribution Box and proceed as follows:

Remove the cover from the Control Board (if one is present).

Remove the Battery clip to allow the Board's memory to drain. (Leave the clip off for a minimum of 10 minutes.)

Replace the EPROM. (The EPROM's legs bend easily. Remove and replace very carefully.)

Replace the Battery clip and cover (if used).

Apply power to the AC distribution box.

Go in the "Setup Mode" and push "F" for Master Reset.

Go in the "Test Mode" and push "0" to clear errors.

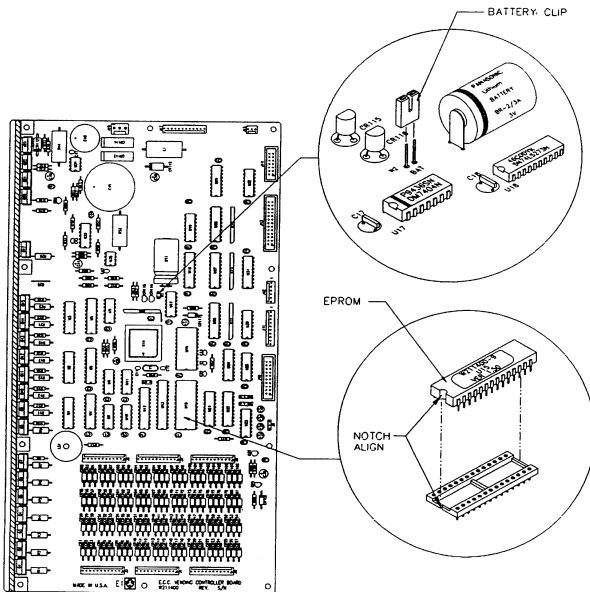

FIGURE 1 - EPROM REPLACEMENT ENTRY



# MAJOR COMPONENT DESCRIPTION

## AC DISTRIBUTION BOX

DN59##/33##  
110 VAC units

Main Power Switch / Plug	Interrupts hot side of incoming power to all components in machine.
15 Amp Outlet (110 VAC)	Provides power to refrigeration unit.
Transformer (T1)	Provides 24 Volt and 12 Volt (center tap) power to the Controller Board.
Fuse (X2 Center)	2 Amp SloBlo; protects primary of T1.
Fuse (X3 Left Side)	10 Amp, 32 Volt, SloBlo; protects 24 Volt input to Controller Board from secondary of T1.
Fuse (X4 Right Side)	2 Amp, SloBlo; protects 12 Volt input to Controller Board from secondary, center tap of T1.

Varistor Across incoming AC power to remove large power spikes.

## REFRIGERATION UNIT

DN59##/33##  
110 VAC units

Compressor	Aspera, 1/2 HP, 115 VAC, 60 Hz, 1 Phase T6213Z Unit uses 13 oz. of 134A refrigerant
Start Relay	110 VAC – T1 9660-041-180 Double Pole, 115 VAC
Start Capacitor	110 VAC - 189227
Thermal Overload	110 VAC - TI MST16AFN-3001
Condenser Fan	16W Motor 110 VAC – FV100CW25S Blade - 10" dia.
Evaporator Fan	Motor 110 VAC - SPGE9HBV1 Blade - 8" dia.

# ELECTRICAL DIAGRAMS & SCHEMATICS

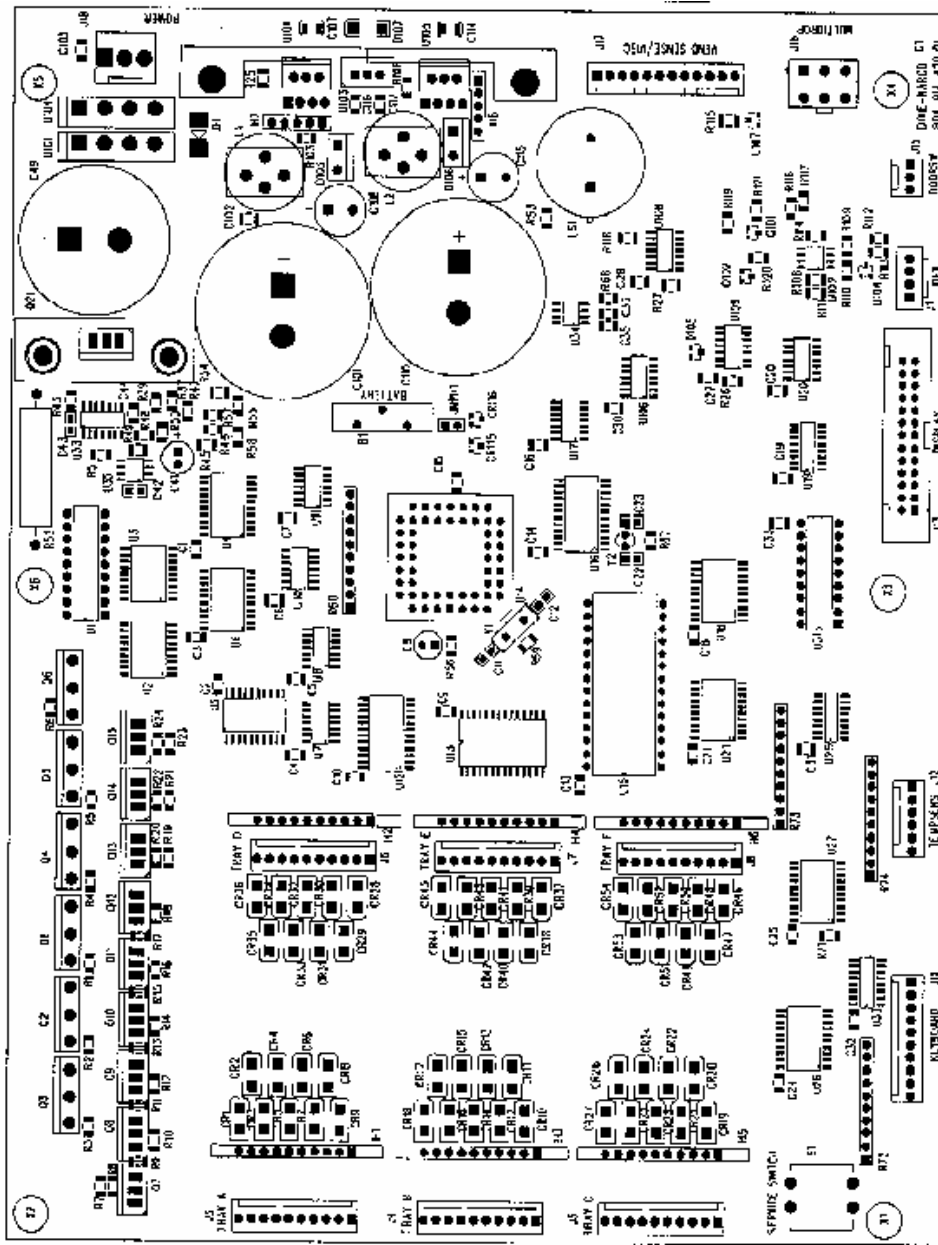
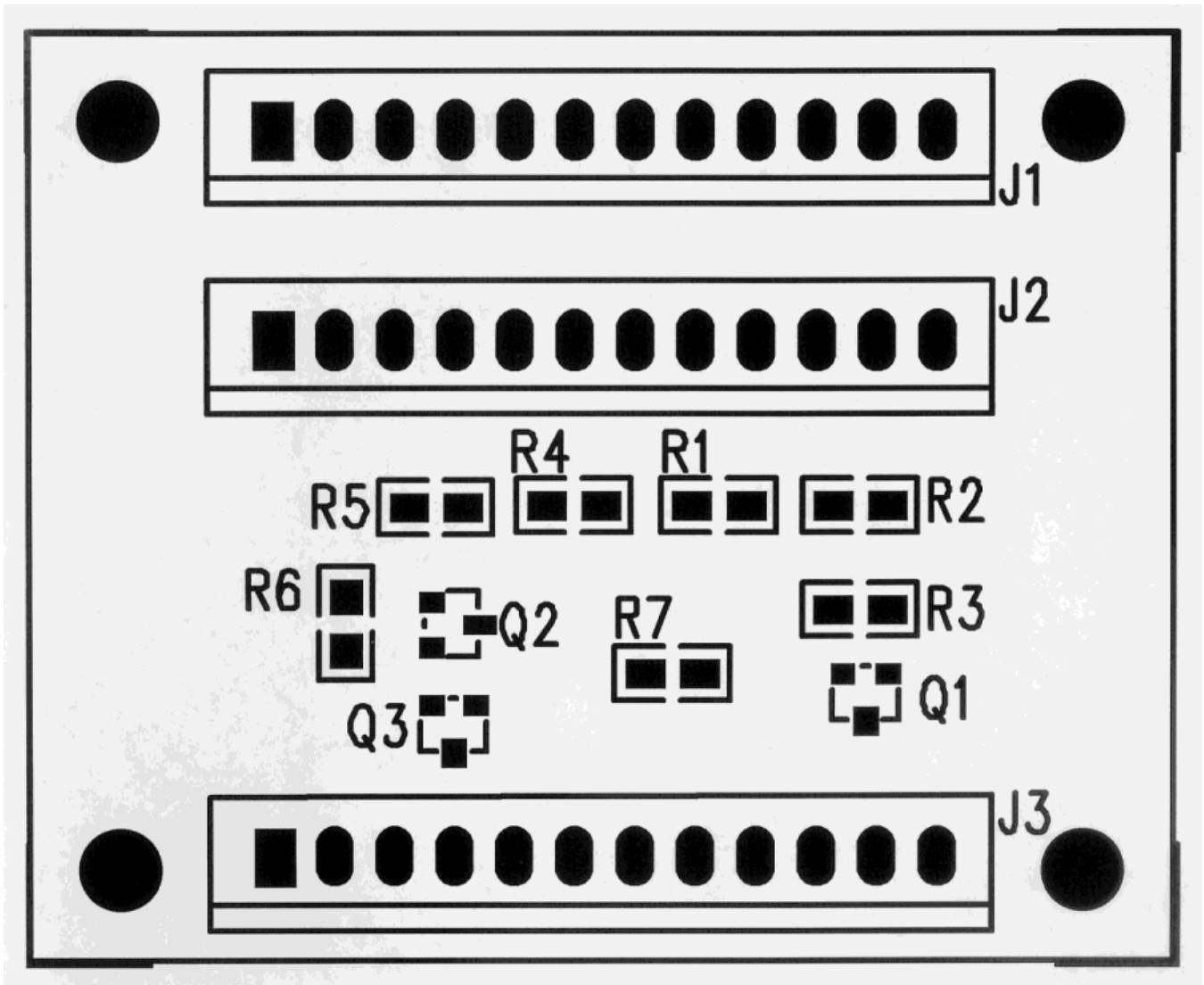

FIGURE 2 – MDB CONTROLLER CONNECTIONS  
DN 59## / 54## / 33## SERIES

ITEM #	CONNECTION	DESCRIPTION
1	J18	Power from AC Distribution Box
2	J17	Vend Sensor
3	J16	Multi Drop Bus
4	J15	Door Interlock Switch
5	J13	Digital Display
6	J12	Temperature Sensor
7	J11	Keypad
8	TRAYS	Bottom Row J3 – A, J4 – B, J5 – C, TOP ROW J6 – D, J7 – E, J8 – 7
9	J1	DEX



**DUAL SENSOR BOARD**

ITEM #	CONNECTION	DESCRIPTION
1	J1	Vend Sensor
2	J2	Vend Sensor
3	J3	Jumper from Main Board

# TROUBLESHOOTING

## COIN ACCEPTANCE ISSUES

PROBLEM	CAUSE	FIX
Coins Returned to Customer With No Credit Issued	<ol style="list-style-type: none"> <li>1. Coin Jam in Mech</li> <li>2. Flight Deck Dirty</li> <li>3. No Power to Mech</li> <li>4. Coin Return Lever Activated</li> <li>5. Vender in Test Mode</li> <li>6. Not Available Time Set</li> <li>7. Defective Coin Mech</li> </ol>	<ol style="list-style-type: none"> <li>1. Clear Jam and Test</li> <li>2. Clean Flight Deck</li> <li>3. Check Harness, Changer to VCU</li> <li>4. Adjust Coin Return Lever</li> <li>5. Close Service Door</li> <li>6. Disable Not Available Time</li> <li>7. Replace Mech</li> </ol>
Will Not Payback Coins	<ol style="list-style-type: none"> <li>1. No Power to Mech</li> <li>2. No Coins in Tubes</li> <li>3. Tubes Programmed Incorrectly (4 Tube Mech)</li> <li>4. Defective Coin Mech</li> </ol>	<ol style="list-style-type: none"> <li>1. Check / Replace MDB Harness</li> <li>2. Fill Coin Tubes with Coins</li> <li>3. Reprogram per Manufacturer Recommendation</li> <li>4. Replace Coin Mech</li> </ol>

## DOLLAR BILL ACCEPTANCE ISSUES

PROBLEM	CAUSE	FIX
Bill Validator will not run.	Prices / tube cash conditions.	Check Mech Tubes.
Takes Bill in Then Rejects it		Check Validator or Replace
Stacks Bill While in Escrow Mode	Max Price Not Yet Reached	
Bill Error Listed in Test Mode	Communication Error with Bill Validator. Bill Validator Reported Error.	
Takes Bill, Gives No Credit	Board, Harness, Validator	Check or Replace Validator Harness, Replace Board

## CONTROL BOARD (VCU)

PROBLEM	CAUSE	FIX
No Power to Controller.	1. AC Box	1. Replace AC box.
??????? Showing on Display	<ol style="list-style-type: none"> <li>1. Incorrect Input to Controller</li> <li>2. Low or Missing 24 Volts</li> </ol>	
Out of Order or other error codes showing on display	RAM Error	Refer to Programming Section on page 14 for specific error codes and cures.
Temp out of Service	No Vendable Selections	

# TROUBLESHOOTING

These charts are intended as a guide to isolate and correct most problems you might encounter. Should your machine scroll 'OUT OF SERVICE', go in the TEST MODE and press "B" to list errors.

## ALL COINS ARE REJECTED

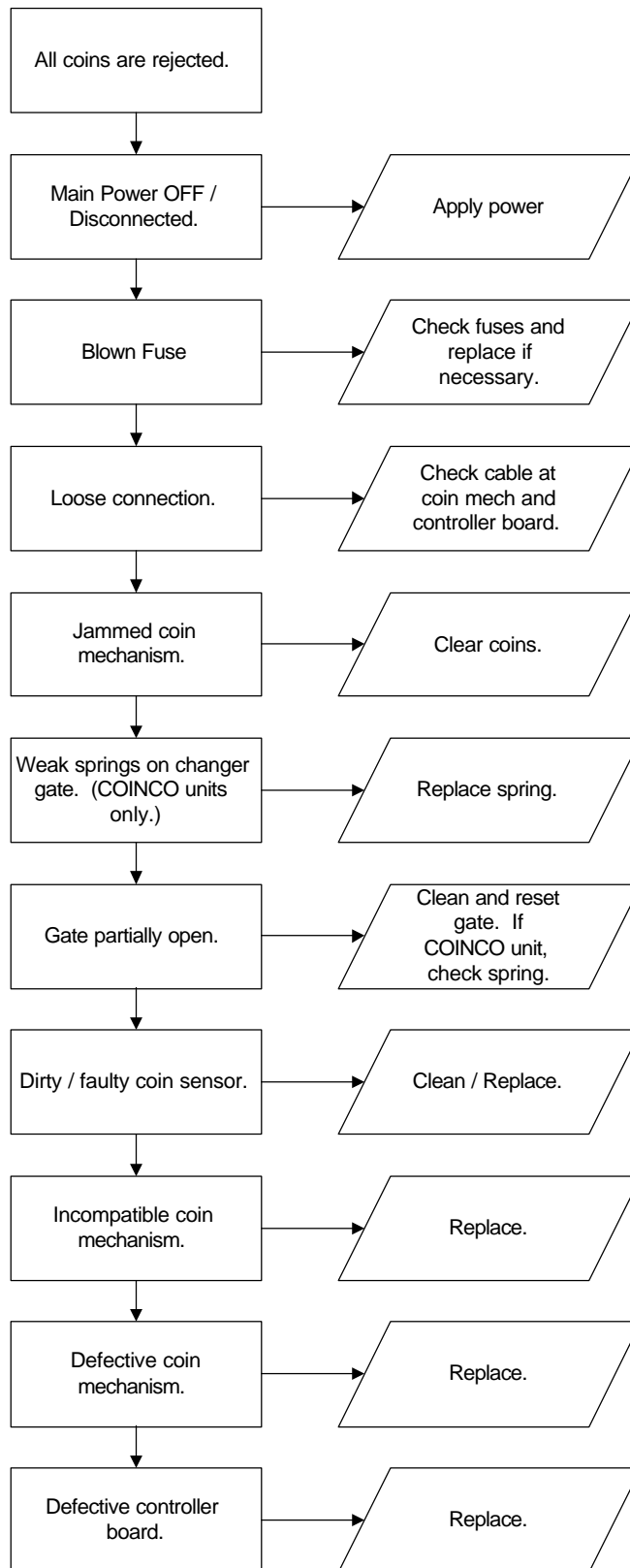

# TROUBLESHOOTING

## ALL BILLS ARE REJECTED

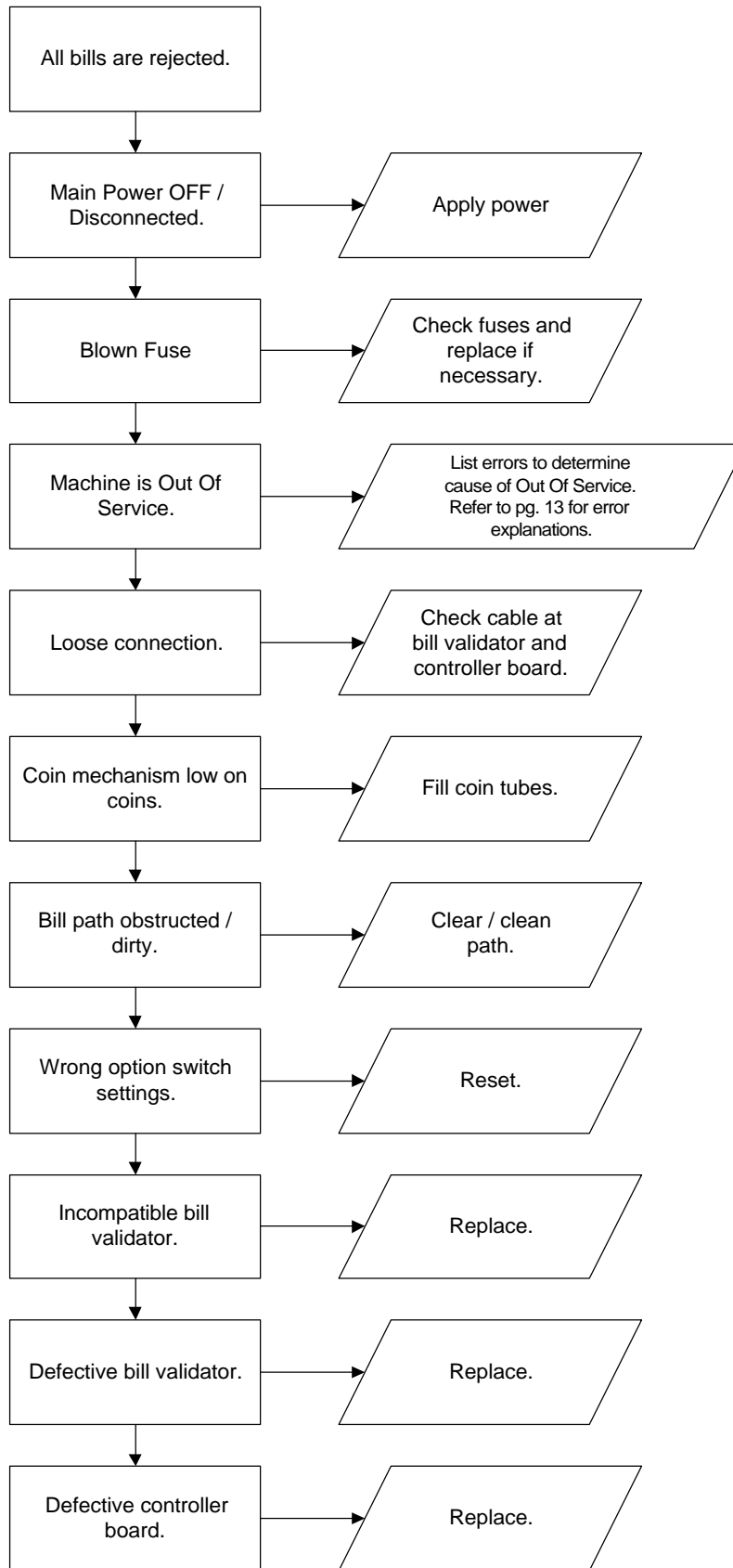

# TROUBLESHOOTING

---

## INCORRECT CHANGE DISPENSED

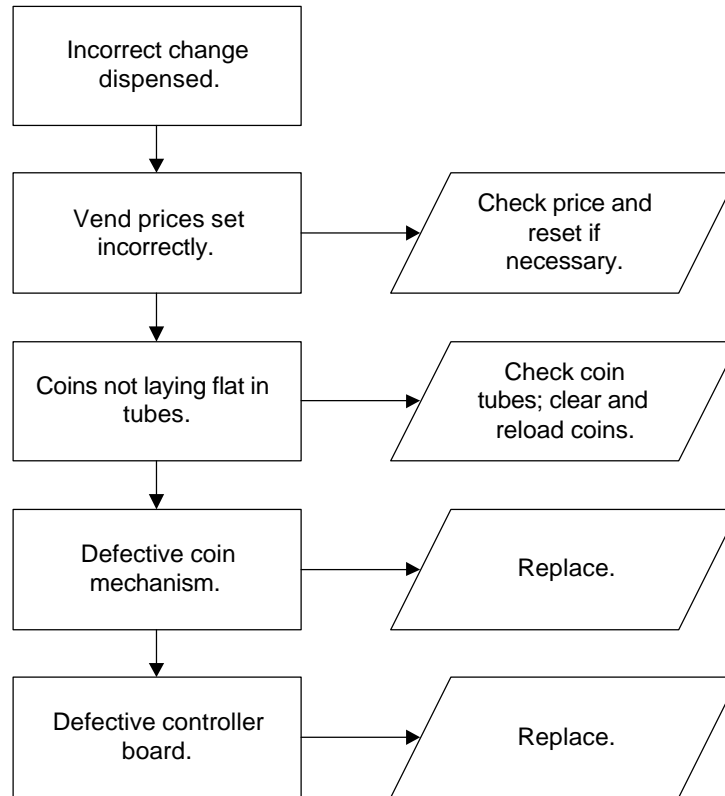

# TROUBLESHOOTING

## SELECTION WILL NOT VEND

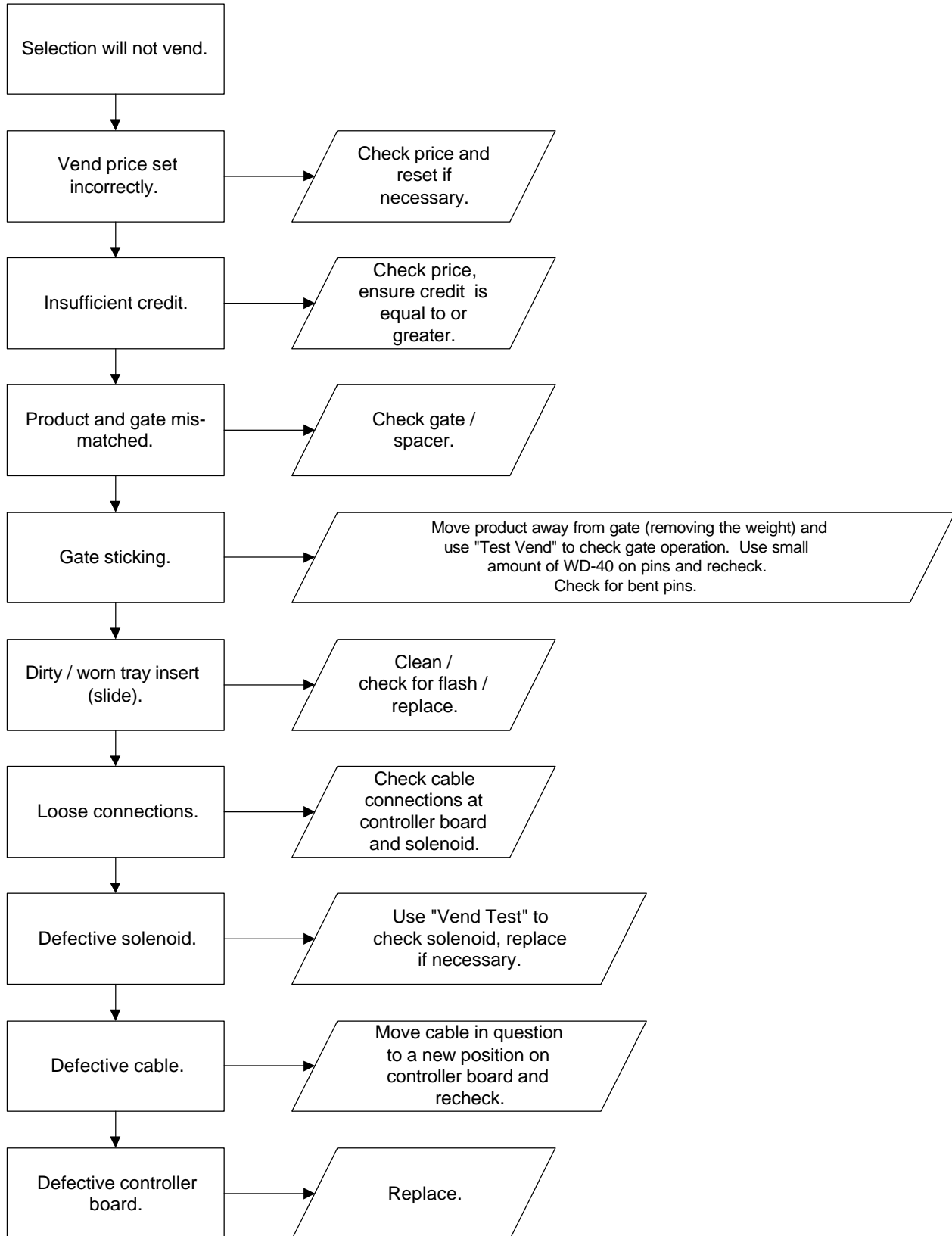



# TROUBLESHOOTING

---

## ICE / FROST ON EVAPORATOR

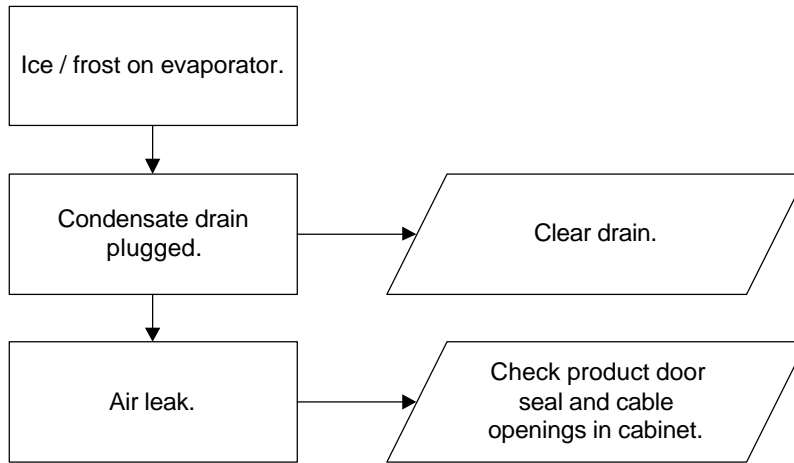

## CONDENSATE ON OUTSIDE OF PRODUCT DOOR

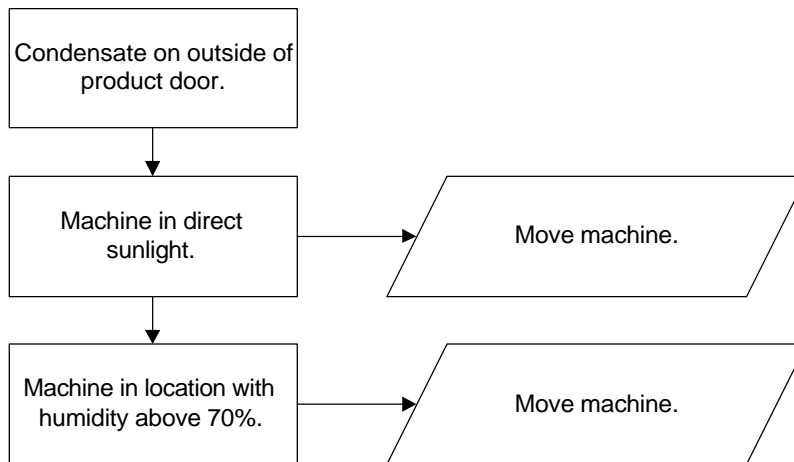

## COMPRESSOR WILL NOT STOP

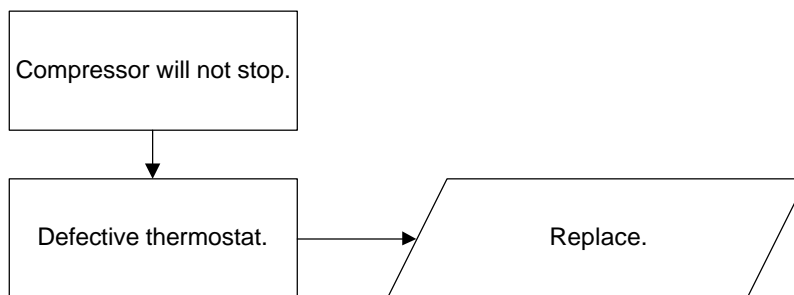

# TROUBLESHOOTING

## COMPRESSOR WILL NOT START

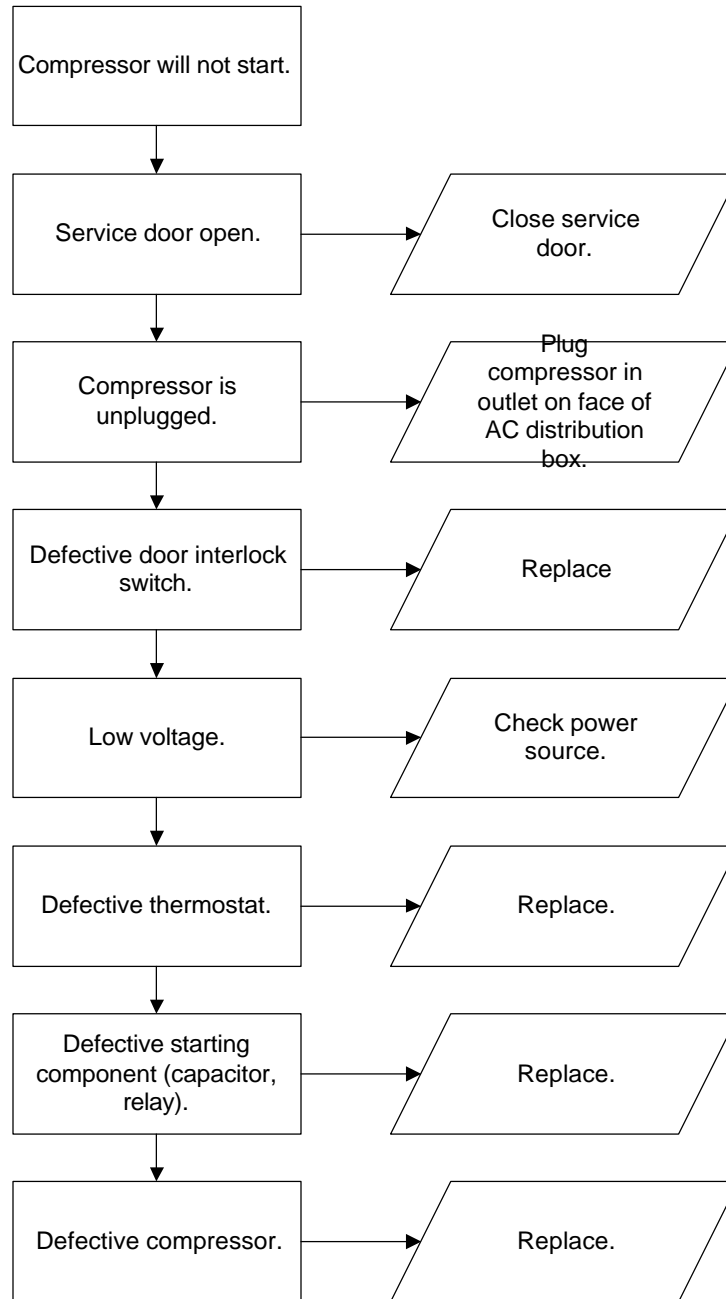

**Troubleshooting Tip:** Use a short 15 Amp extension cord and plug the compressor directly into the wall outlet. This will bypass the AC distribution box.  
**Note:** For Testing Purposes Only.

# TROUBLESHOOTING

## MACHINE NOT COOLING

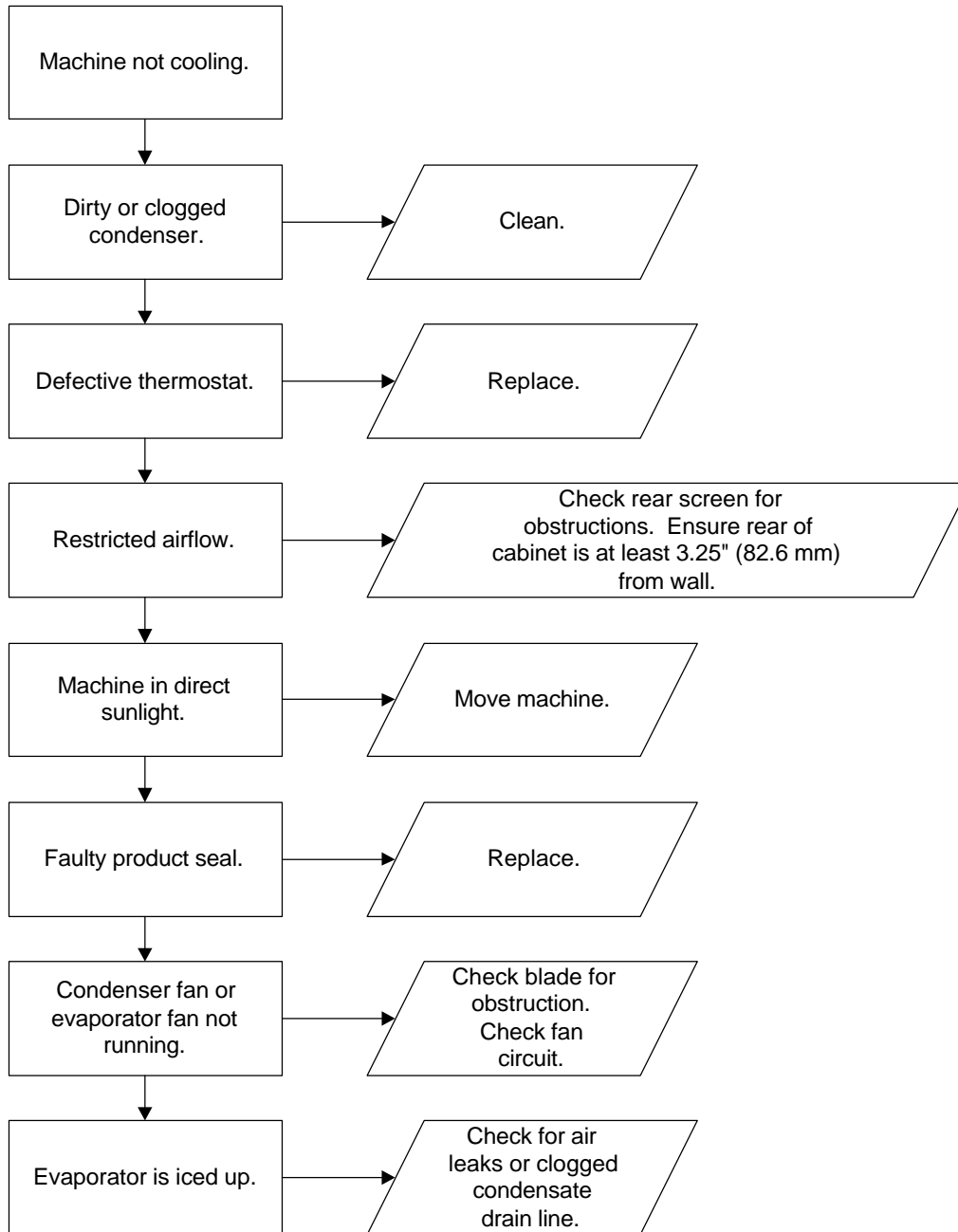

# TROUBLESHOOTING

---

## TROUBLESHOOTING “SELECTION WILL NOT VEND” ISSUES

1. Selection will not vend
  - a. Does a different selection vend?
    - i. Shelf harness swapped
      1. Perform TEST VEND in TEST MENU ensure proper selection vends
    - ii. Space-To-Sales has been enabled
      1. Check STS configuration in SETUP MENU 2
  - b. Did the gate actuate at all?
    - i. Gate “rattled” or solenoid clicked, but gate did not fully actuate
      1. Gate Sticking
        - a. Shuttle bad
        - b. Bent pins
        - c. Front knuckle pin not connected to solenoid
      2. Possible Solenoid drive problem
        - a. Check error list. Does list show “LOW LINE” or “LOW 28V”?
          - i. Bad AC box
          - ii. Bad electrical supply to vender
          - iii. Defective board
        - b. Check error list. Does list show “VEND ERR”, with selection included in vend error list when pressing “A”?  
Perform vend test on selection. Does vend test report “HC+” or “HC”, or “LC”, or “NC” instead of “OK”?
          - i. Only occurs on one solenoid
            1. Defective solenoid
            2. Solenoid-harness connection
          - ii. Occurs on entire shelf
            1. Harness issue
            2. Defective board
            3. Bad AC box
            4. Bad electrical service to vender
          - iii. Occurs on same column, multiple shelves (A2, B2, C2, D2, E2)
            1. Defective board
            2. Bad AC box
            3. Bad electrical service to vender
      - ii. Gate did not rattle or solenoid did not click
        1. Software attempted vend
          - a. Check error list. Does error list show “LOW LINE” or “LOW 28V”?
            - i. Bad AC box
            - ii. Bad electrical service to vender
          - b. Check error list. Does error list show “VEND ERR”, with selection included in vend error list when pressing “A”?  
Perform vend test on selection. Does vend test report “HC+” or “HC”, or “LC”, or “NC” instead of “OK”?
            - i. Only occurs on one solenoid
              1. Defective solenoid
              2. Solenoid-harness connection
            - ii. Occurs on entire shelf
              1. Harness issue
              2. Defective board
              3. Bad AC Box
              4. Bad electrical supply to vender
            - iii. Occurs on same column, multiple shelves (A2, B2, C2, D2, E2)
              1. Defective board
              2. Bad AC box
              3. Bad electrical service to vender

# TROUBLESHOOTING

---

- ii. Gate did not rattle or solenoid did not click (continued)
  - 2. Software did not attempt to vend
    - a. Check error list. Does error list show "VEND ERR", with selection included in vend error list when pressing "A"?
      - i. A previous vend operation, vend test, or self test indicated a solenoid error
    - b. Software has selection identified as "sold out"
      - i. Drop sensor is enabled, column is empty
        - 1. Refill selection
        - 2. Disable drop sensor
      - ii. Drop sensor is enabled, product was not detected by drop sensor on a previous vend
        - 1. Ensure software is 030.51 or greater
        - 2. Cycle door to reset sold outs
        - 3. Realign sensor(s) to catch product
        - 4. Disable drop sensor
    - c. Selection is placed under SETUP MODE, HEALTH GUARD
    - d. Selection is placed under SERVICE MODE, SET COOL DOWN function.
    - e. Selection has been disabled through SERVICE MODE, ENABLE ITEM function
    - f. SETUP MODE 2, VEND LIMIT function set to non-zero value.
      - i. Cycle door to reset vend limits / sold out
- iii. Gate did actuate
  - 1. Product and gate mismatch
    - a. Check correct spacer used
  - 2. Dirty / worn tray slide with pusher
    - a. Check slide with pusher

# ELECTRICAL DIAGRAMS & SCHEMATICS

## DN59## VENDER

(Bev Max Diagram shown, Entry Diagram to be provided at a later date)

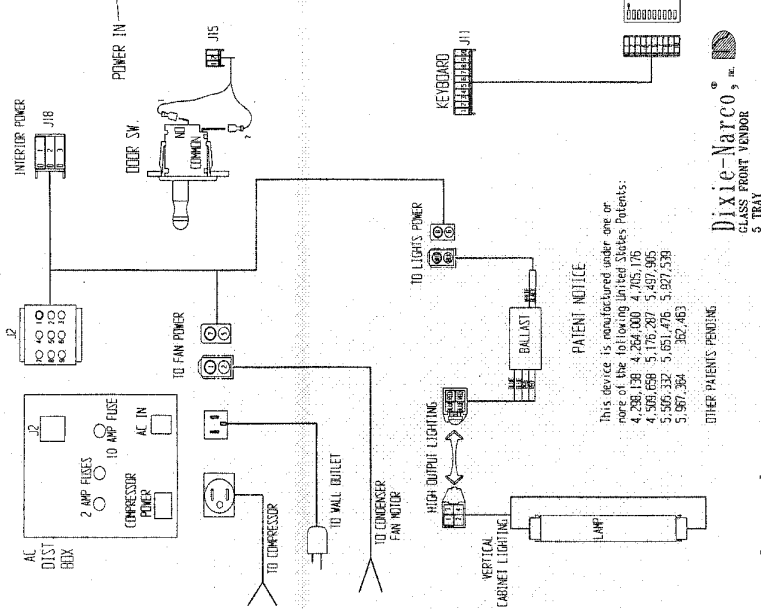
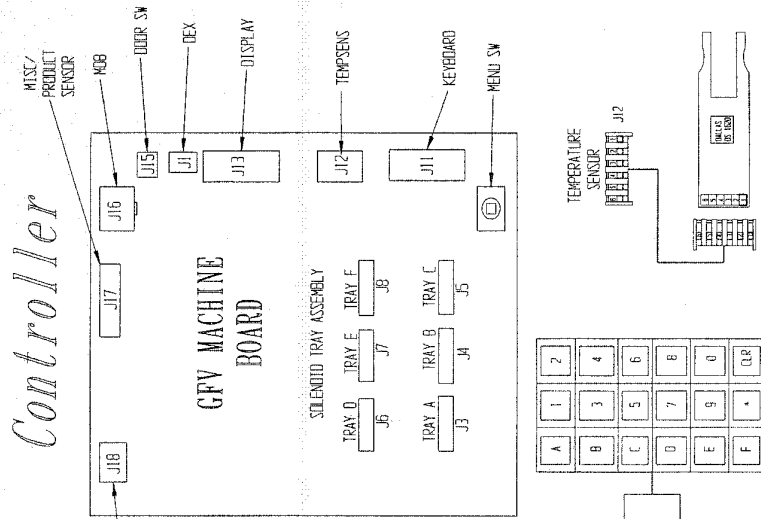
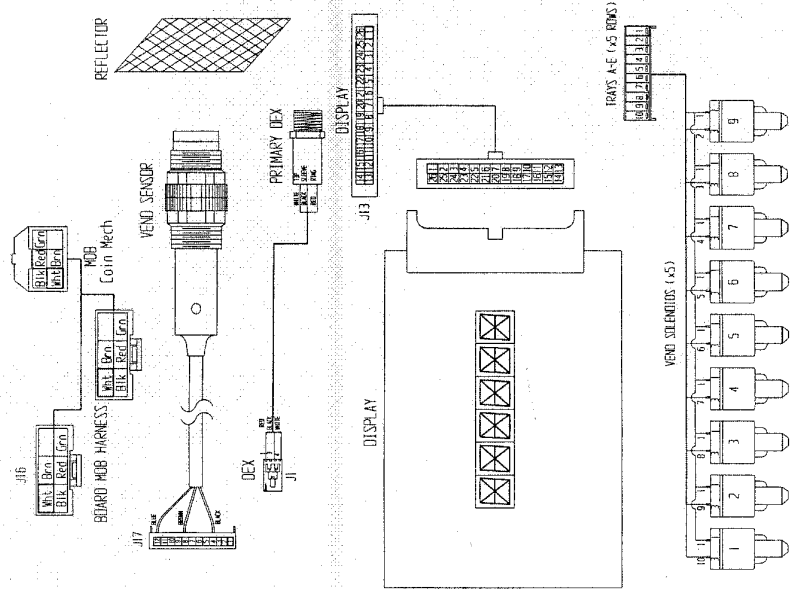

**PATENT NOTICE**  
 This device is manufactured under one or more of the following United States Patents:  
 4,238,131 4,264,000 4,205,176  
 4,508,659 5,176,287 5,497,995  
 5,566,332 5,651,476 5,827,539  
 5,987,364 362,463

**Dixie-Narco, Inc.**  
 CLASS FRONT VENDOR  
 3 TRAY

**Legend**



**Legend**



All Connectors are WIRE SIDE VIEW

All Connectors are WIRE SIDE VIEW

# ELECTRICAL DIAGRAMS & SCHEMATICS

DN33## VENDER

(Bev Max Diagram shown, Entry Diagram to be provided at a later date)

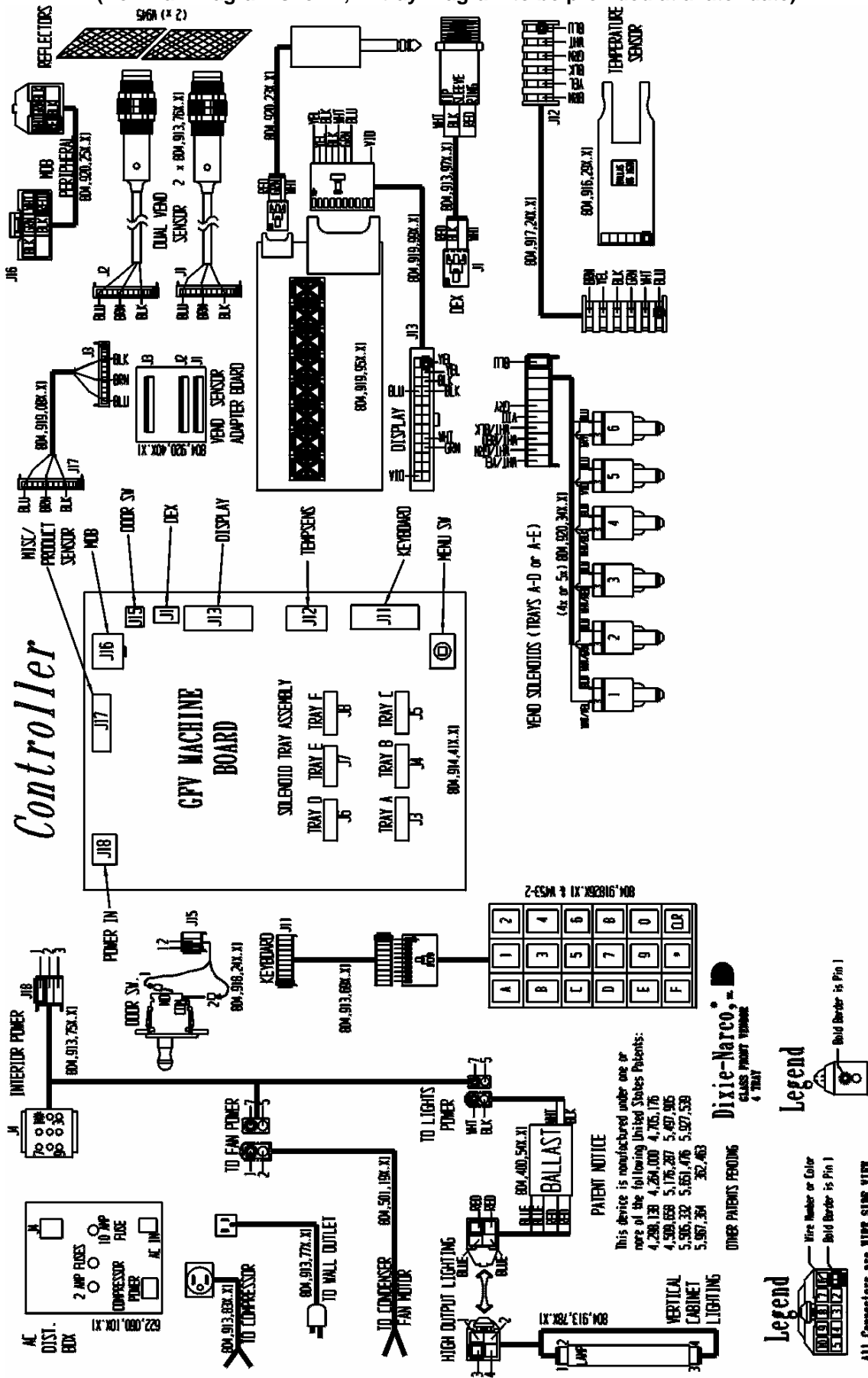

**PATENT NOTICE**

This device is manufactured under one or more of the following United States Patents:

4,288,138 4,264,000 4,765,776  
 4,308,658 5,176,287 5,497,985  
 5,505,332 5,651,476 5,927,528  
 5,957,364 362,463

**OTHER PATENTS PENDING**

**Dixie-Narco, Inc.**  
 CLASS FRONT VENDING  
 4 TRAY

# ELECTRICAL DIAGRAMS & SCHEMATICS

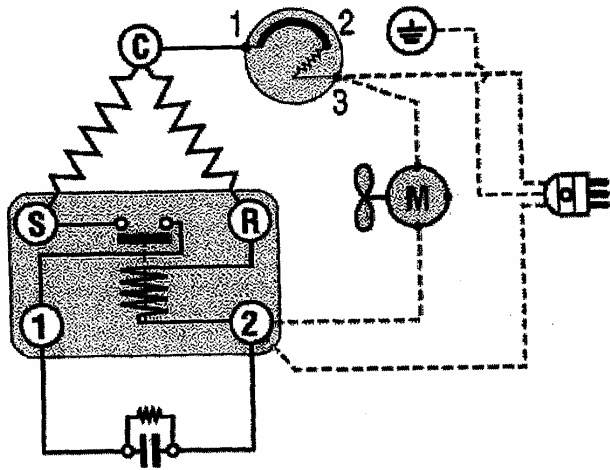

Symbol	Description
	Current Start Relay with Capacitor Connections
	Start Capacitor
	Overload Protector
	Fan
	Single Phase Motor
	Earth Connection
	Single Phase Supply
	Common
	Run
	Start
	Factory Made Connections
	Connections to be made

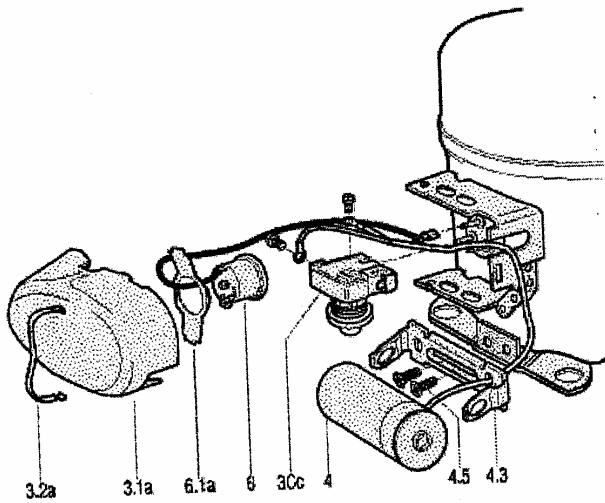

Ref	Symbol	Description
3Cc		Current Start Relay with Capacitor Connections
3.1a		Cover
3.2a		Cover Spring
4		Start Capacitor
4.3		Capacitor Clamp
4.4		Capacitor fixing bracket
4.5		M5 Self-tapping Screw
6		Overload Protector
6.1a		Overload Spring

DN59##/33## Compressor Wiring Diagram



# ELECTRICAL DIAGRAMS & SCHEMATICS

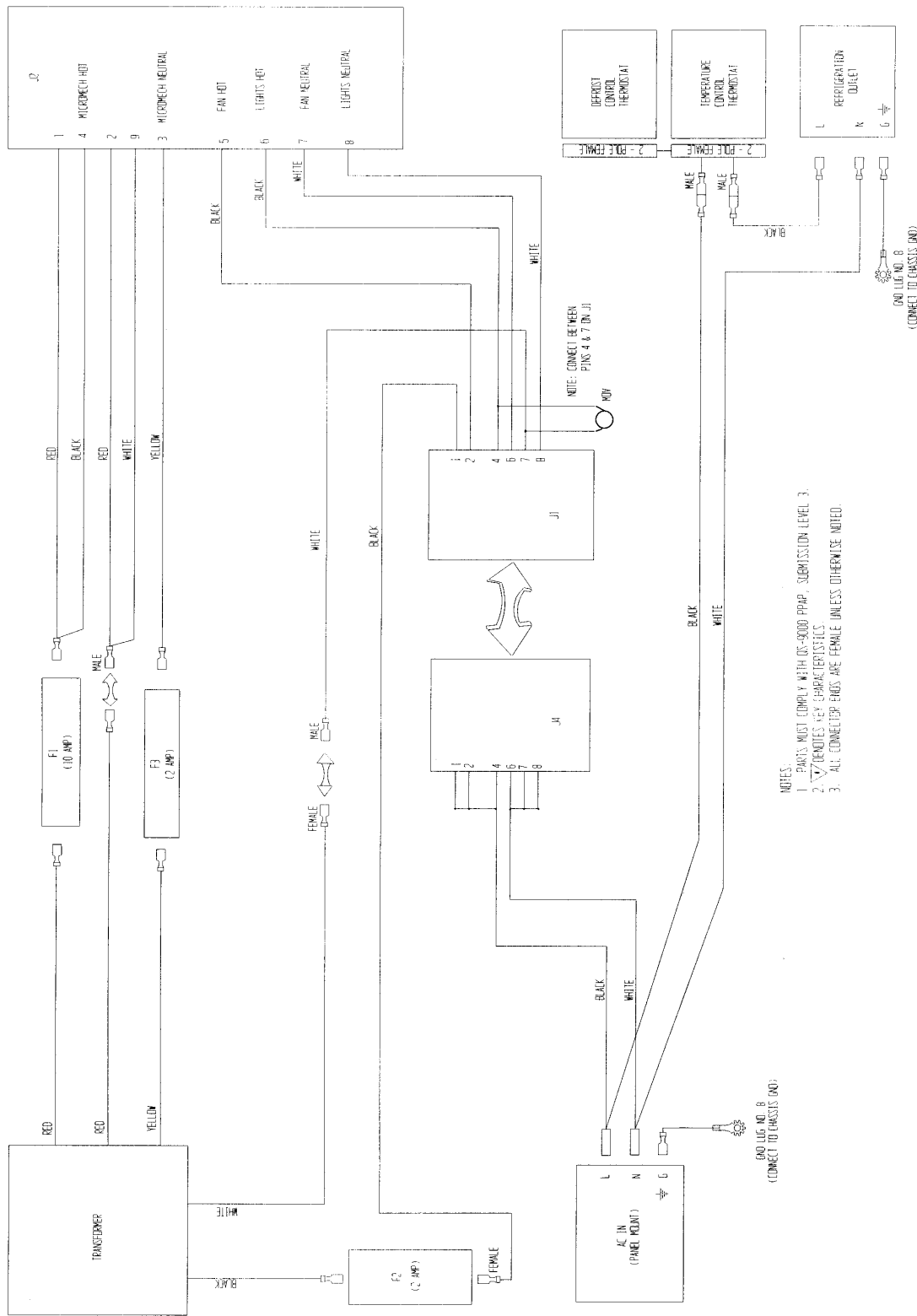

DN59##/33##  
 AC DISTRIBUTION BOX SCHEMATIC DOMESTIC  
 FIGURE 3

# ELECTRICAL DIAGRAMS & SCHEMATICS

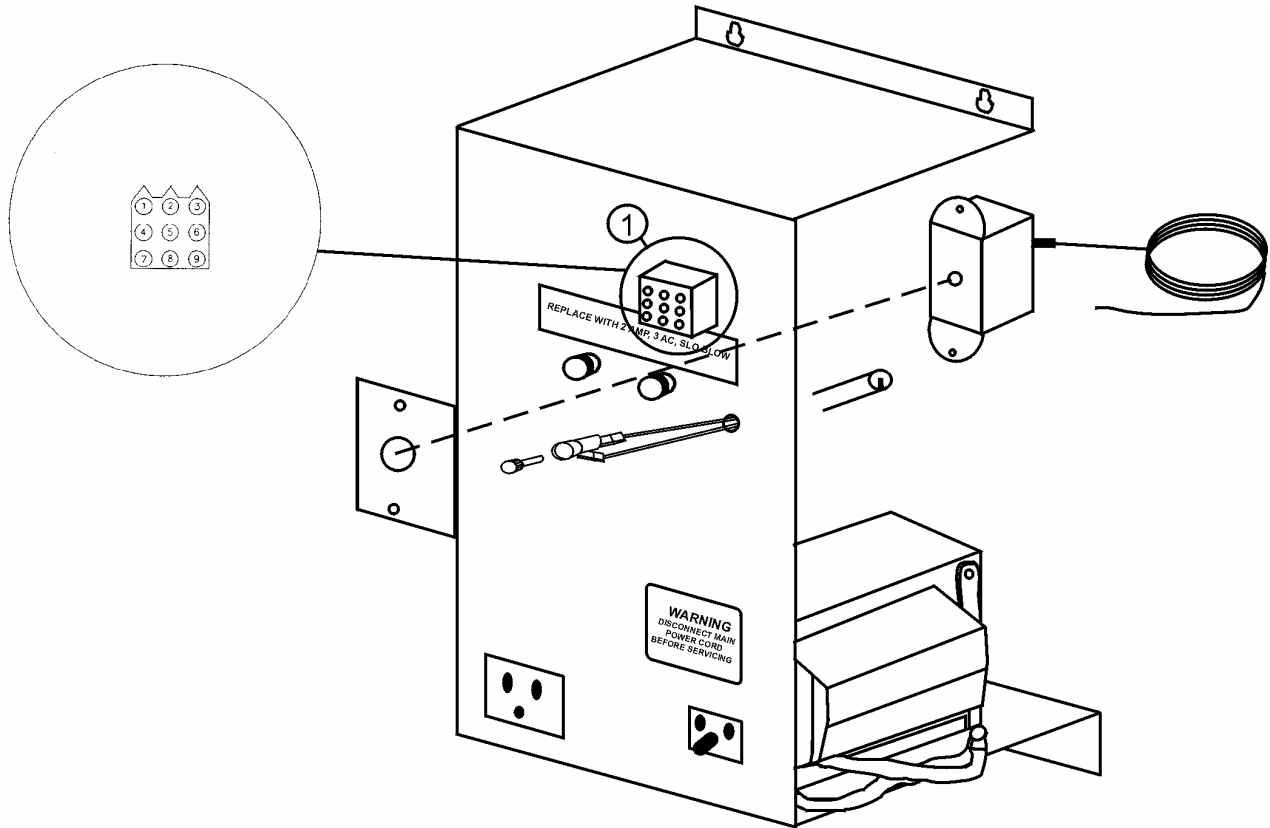

AC VOLTAGES			
Between Pins		Domestic Reading	Export Reading
1	2	24 VAC	24 VAC
1	3	12 VAC	12 VAC
2	3	12 VAC	12 VAC
4	9	24 VAC	24 VAC
5	7	115 VAC	220 VAC
6	8	115 VAC	220 VAC

AC DISTRIBUTION BOX, J2 VOLTAGES – ITEM 1

# ELECTRICAL DIAGRAMS & SCHEMATICS

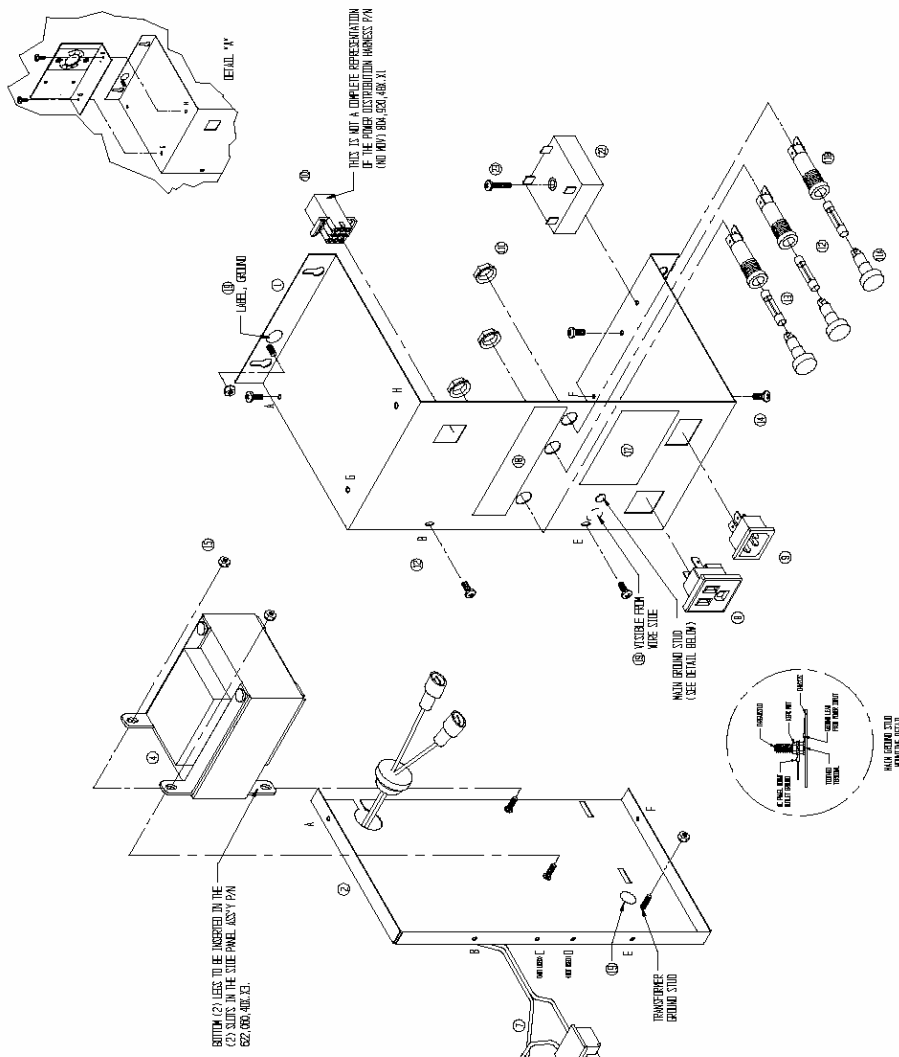

ITEM	PART NUMBER	DESCRIPTION	QTY.
1	622.000.000.X3	BOX, AC DISTRIBUTION ASSY 2145	1
2	622.000.000.X3	ASSY, AC DISTRIBUTION BOX SIDE PANEL 2145	1
3	622.000.000.X3	BRACKET, DUAL TEMPERATURE CONTROL	1
4	804.505.504.X1	TRANSFORMER, CONDENSER TYP	1
5	802.800.800.X1	TEMPERATURE CONTROL RE	1
6	802.800.800.X1	TEMPERATURE CONTROL	1
7	804.504.504.X1	HARNESS, DUAL THERMOSTAT	1
8	WIRE	OUTLET, AC PANEL MOUNT	1
9	804.503.503.X1	PLUG, DIN 2145 PUMP INLET	1
10	804.503.503.X1	HARNESS, PUMP DISTRIBUTION AND AUX LEV	1
11	114-E-1060	FACE-ROUNDER PANEL MOUNTED (3 PCS EACH)	3
12	WIRE	FACE 2 AMP 250V 30.0 BLU	2
13	WIRE	FACE 10 AMP 250V	1
14	800.500.500.X1	SCREEN, 10-32 X 3/8 PANEL PWR TYPE I	9
15	800.500.500.X1	WHT, REFS 10-32	4
16	802.800.800.X1	LABEL, TEMPERATURE CONTROL	1
17	802.800.800.X1	LABEL, AC DISTRIBUTION BOX DISCONNECT	1
18	802.800.800.X1	LABEL, AC DISTRIBUTION BOX FUSES	1
19	802.800.800.X1	LABEL, GROUND	3
20	800.502.502.X1	CLIP, TEMPERATURE CONTROL	1
21	800.502.502.X1	SCREEN, 10-32 X 1.5 PHIL PAN	2
22	804.504.504.X1	CORDE, CAP 1, MOD 20R	1
23	800.000.000	SCREEN, 10-32 X 1/8 PHIL PAN	1

ASSY AC BOX DOMESTIC  
T8 Electronic

# PARTS LIST

<b>PARTS LIST AND DIAGRAMS .....</b>	<b>45 – 75</b>
Machine Front View.....	45 – 46
Recovery Unit.....	47
Cabinet Detail.....	48 – 49
Service Door Front .....	50 – 51
Service Door Inside A.....	52 – 53
Service Door Inside B.....	54 – 55
Tall Tray Detail .....	56 – 57
Snack Trays / Helix.....	58 – 59
Snack Trays Detail .....	60 – 61
AC Distribution Box .....	62 – 63
Lighting .....	64
Refrigeration Unit DN59##/33## Fin & Tube Condenser .....	65 – 66
Electronics.....	67
Harnesses.....	68 – 69
Labels / Decals / Misc.....	70
Screws & Nuts.....	71 – 72
Washers, Bolts, & Misc. Hardware.....	73 – 75

# PARTS LIST AND DIAGRAMS

## MACHINE FRONT VIEW

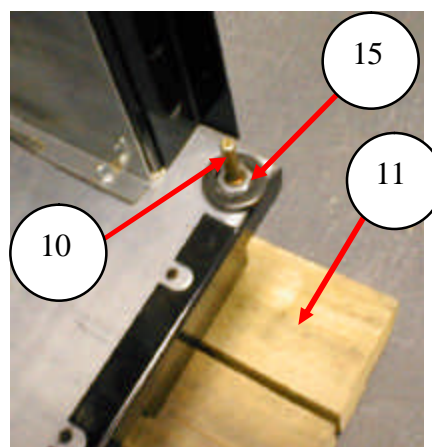
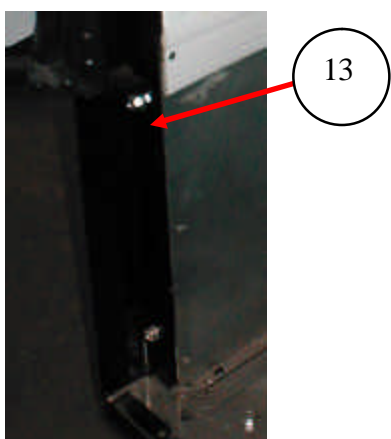
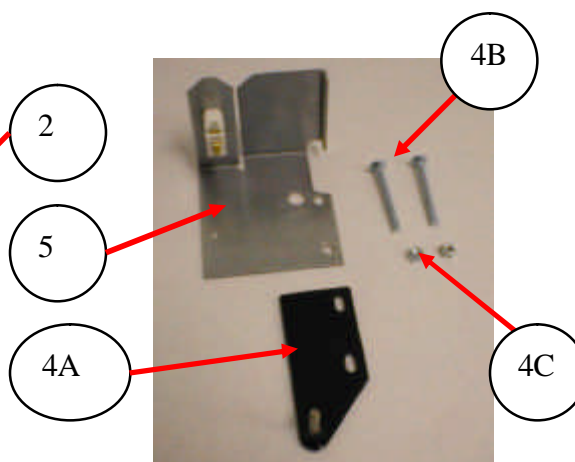
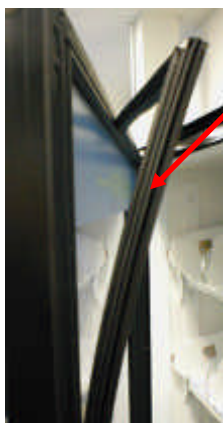
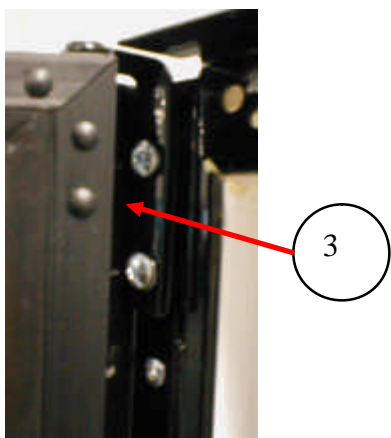
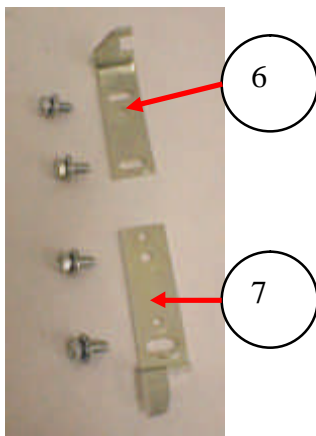
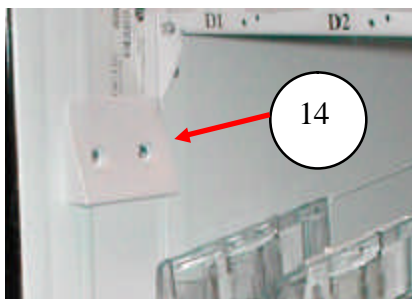

# PARTS LIST AND DIAGRAMS

## MACHINE FRONT VIEW

ITEM	PART DESCRIPTION	DN59##	DN33##
1	Door Assembly, Glass	800,101,89x.x1	800,102,18x.x1
2	Gasket	800,102,03x.x1	801,817,50x.x1
3	Top Hinge Glass Door	801,305,70x.x1	Same
4A	Top Hinge Service Door (All)	W334	Same
4B	Carriage Bolt, 1/4 -20 X 2.5"	900,202,20x.x1	Same
4C	Hex Nut, 1/4-20	900,800,67x.x1	Same
5	Service Door Stop	627,050,42x.x3	Same
6	Latch, 3-Point Lock	801,305,58x.x1	Same
7	Strike, Door Lock, 3-Point	W296	Same
8	Leg Assembly, Steel, Formed	801,305,65x.x1	Same
9	Leg Leveler, 5/8	900,502,49x.x1	Same
10	Bottom Hinge, Service Door	800,503,33x.x1	Same
11	Shipping Boards	805,410,94x.x1	Same
12	Bottom Skirt	627,020,19x.x3	635,020,11x.x3
13	Bottom hinge Glass Door	W326	Same
14	Deflector, Plastic Wedge	801,811,07x.x1	Same
15			
	Part numbers & descriptions are subject to change with out notice. NA = Not applicable TBD = To be determined		

# PARTS LIST AND DIAGRAMS

## RECOVERY UNIT

ITEM	PART DESCRIPTION	DN59##	DN33##
1	Assy., Recovery Unit w/ Anti Pilfer Kit	801,820,55x.x1	801,820,59x.x1
2	Segmented Door Assembly, Recovery Unit	TBD	TBD
3	Gasket (Seal)	902,100,32x.x1	TBD
4	Assembly, Connect Quick Cabinet	645,074,10x.x3	Same
5	Vend Sensor Kit		

Part numbers & descriptions are subject to change with out notice.  
 NA = Not applicable  
 TBD = To be determined

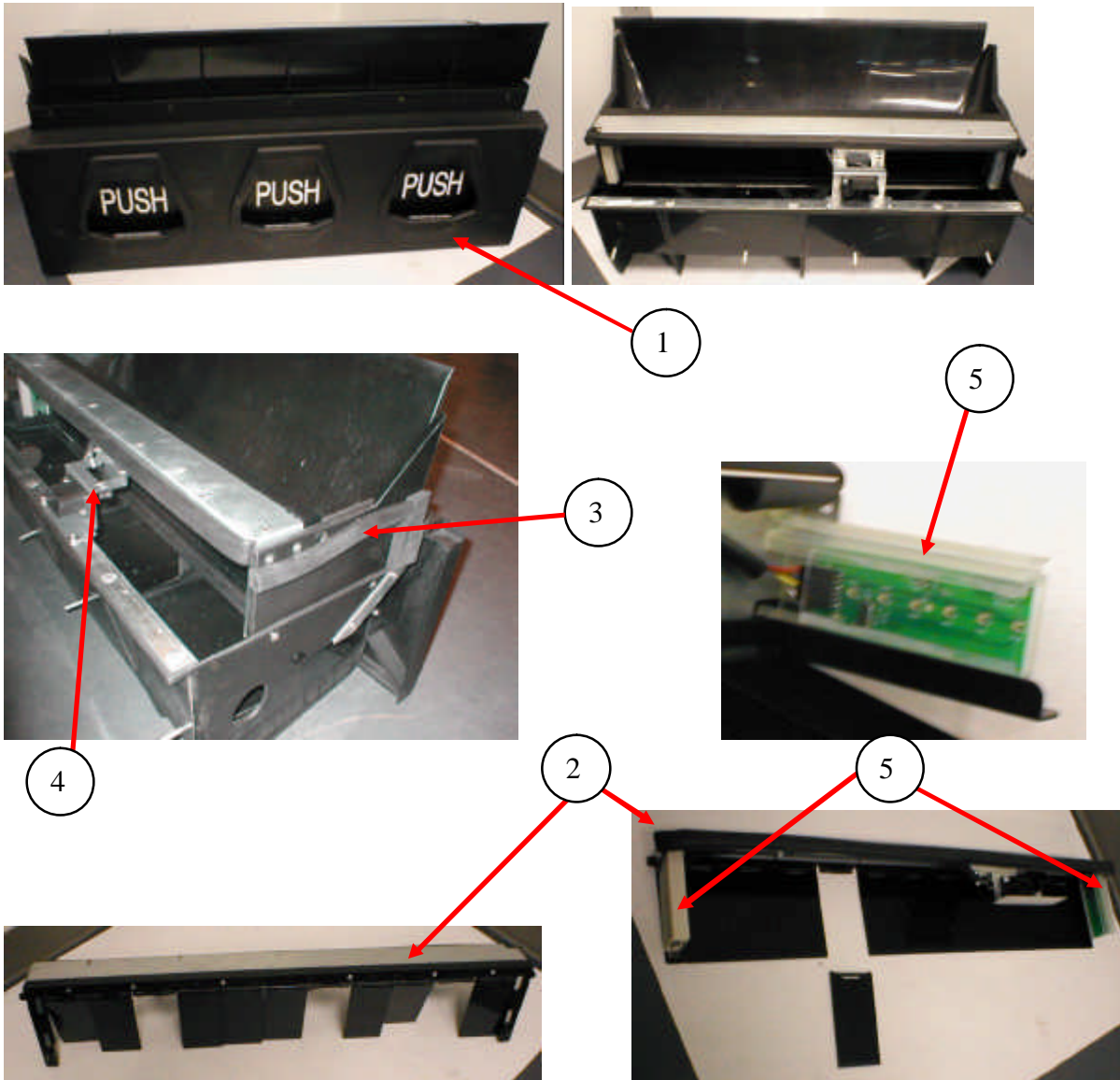

# PARTS LIST AND DIAGRAMS

## CABINET DETAIL

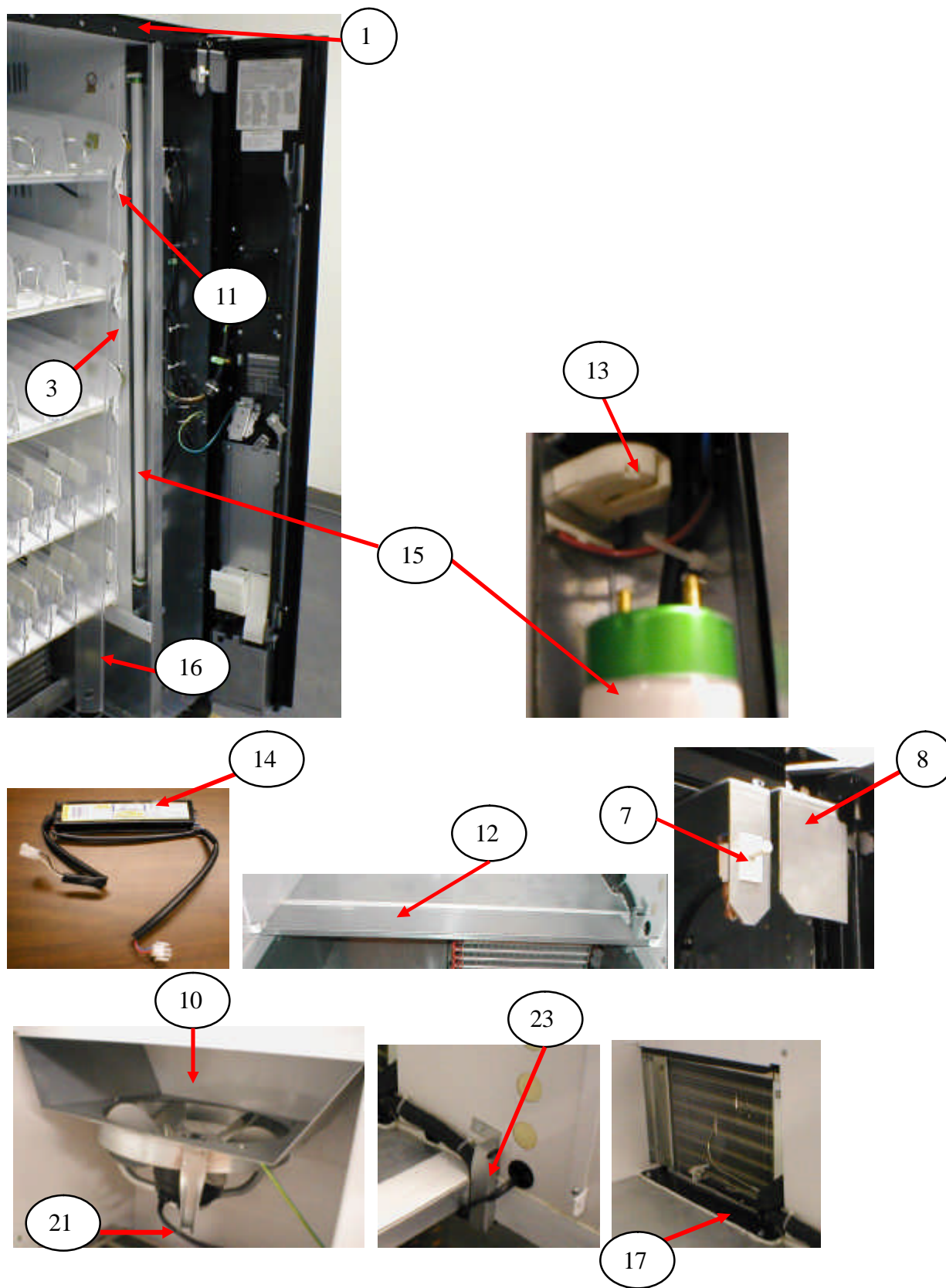



# PARTS LIST AND DIAGRAMS

## CABINET DETAIL

ITEM	PART DESCRIPTION	DN59##	DN33##
1	Left Tray Mounting Bracket, Enray	627,070,21x.x3	Same
2	Rear Tray Support Bracket, Enray	627,070,23x.x3	Same
3	Right Tray Mounting Bracket, Enray	627,070,22x.x3	Same
4	Security Angle Hinge, Left	627,020,11x.x3	Same
5	Security Angle Top	627,020,13x.x3	635,020,06x.x3
6	Security Angle Right	627,020,12x.x3	Same
7	Switch Door	804,100,77x.x1	Same
8	Service Door Stop	627,050,42x.x3	Same
9	Brace, Rear Base Plate	622,020,08x.x3	Same
10	Evaporator Fan Assembly (120V/60Hz, 9W)	622,041,10x.x3	Same
11	Tray Support Screw #8-18x1/2 Phil Pan	900,301,50x.x1	Same
12	Bottom Tray Guard	627,071,10x.x3	635,070,60x.x3
13	Lamp Holder Assembly (includes base and harness) 110V	622,062,50x.x3	Same
	Lamp Holder Assembly (includes base and harness) 220V	622,061,50x.x3	Same
14	Assembly, Ballast 120V/60Hz Electronic (Sylvania) T8	804,400,69x.x1	Same
	Assembly, Ballast 120V/60Hz Electronic (Advance) T8	804,400,68x.x1	Same
	Assembly, Ballast 220V / 50 Hz	622,062,00x.x3	Same
15	Lamp, Fluorescent T8 48" F32T8TL841	804,700,65x.x1	Same
16	Lens, Lamp Extrusion	801,904,15x.x1	Same
17	Evaporator Drain Pan Assembly	622,041,20x.x3	Same
18	Angle, Door Stiffener Recovery	622,070,05x.x3	Same
19	Vertical Edge Cover Strip	803,865,86x.x1	Same
20	Top Edge Cover Strip	803,866,37x.x1	Same
21	Evaporator Fan Harness	804,922,37x.x1	Same
22	Evaporator Duct Air Deflector	W448	Same
23	Suction Tube Guard	W270	Same
24	Ingress Guard (Service Item)	622,050,39x.x3	635,050,13x.x3
	Part numbers & descriptions are subject to change with out notice. NA = Not applicable TBD = To be determined		

# PARTS LIST AND DIAGRAMS

## SERVICE DOOR (FRONT)



1



3

5

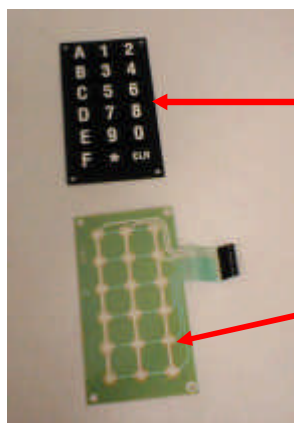

7

8



6



# PARTS LIST AND DIAGRAMS

## SERVICE DOOR (FRONT)

ITEM	PART DESCRIPTION	DN59##	DN33##
1	Service Door Assembly, 3 Point Lock	627,051,50x.x3	Same
	Service Door Assembly, Double Knock Out, 3 Point Lock	TBD	Same
2	Coin Return Service Door Bezel Label	803,857,25x.x1	Same
3	Bezel, Service Door	801,816,01x.x1	Same
4A	Carriage Bolt	W718	Same
4B	Nut	W906	Same
5A	Assembly, Coin Return Lever	800,502,98x.x1	Same
5B	Coin Return Lever Limiter	801,305,22x.x1	Same
6	T-Handle Assembly	801,518,06x.x1	Same
6A	Nut, 1/2-20 Hex	801,518,02x.x1	Same
6B	Washer	801,518,03x.x1	Same
6C	90 Degree Locking Cam	801,518,04x.x1	Same
6D	Pawl	801,518,05x.x1	Same
6E	E-Ring	801,507,34x.x1	Same
6F	Lock Body, Flush Mount	801,507,98x.x1	Same
6G	Hex Washer, #29-34	901,503,08x.x1	Same
6H	Cross Pin, T-Handle	901,503,09x.x1	Same
6I	T-Handle Spring	901,503,05x.x1	Same
6J	T-Handle	801,505,73x.x1	Same
7	Button Array Keypad, Rubber	W453-2	Same
8	Keypad, Membrane Switch	804,918,26x.x1	Same
Part numbers & descriptions are subject to change with out notice. NA = Not applicable TBD = To be determined			

# PARTS LIST AND DIAGRAMS

## SERVICE DOOR (INSIDE - A)

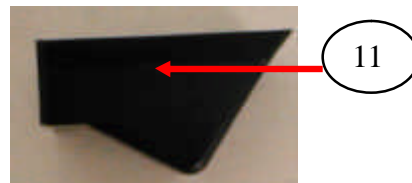
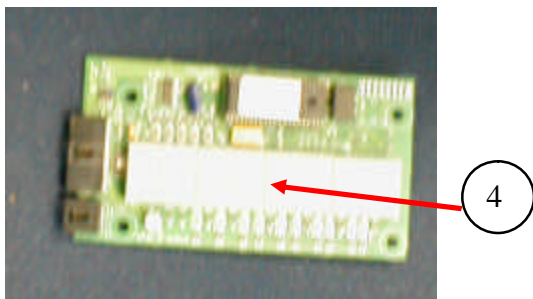
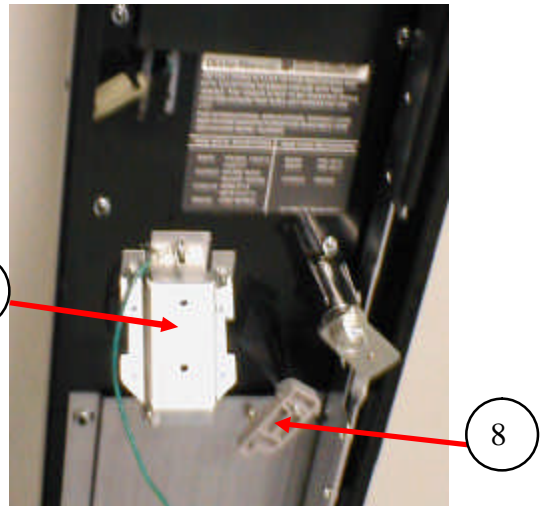
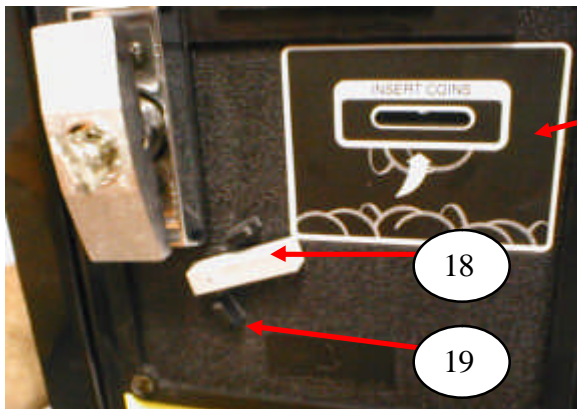
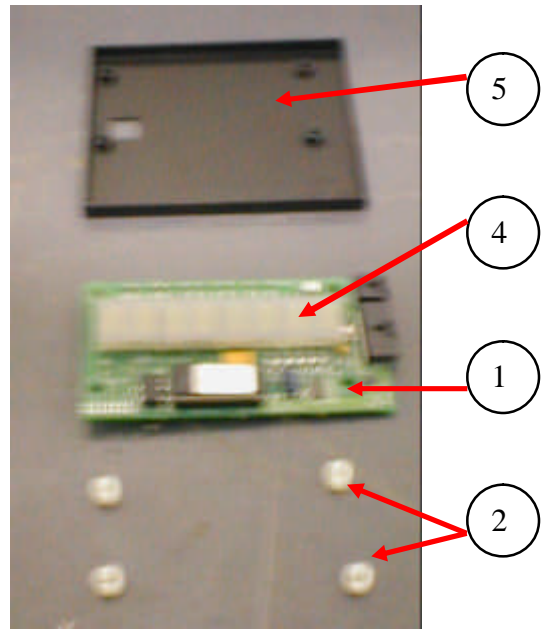
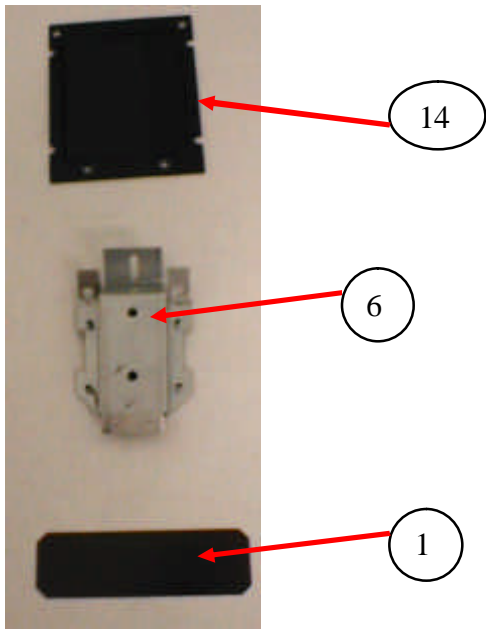

# PARTS LIST AND DIAGRAMS

## SERVICE DOOR (INSIDE - A)

ITEM	PART DESCRIPTION	DN59##	DN33##
1	Display Filter, Red	W367	Same
2	Display Spacer – standoff	901,001,46x.x1	Same
3	Bearing, Service Door (not shown)	W737	Same
4	Assembly. Display IR Capable	804,919,95x.x1	Same
5	Cover, Display	W121	Same
6	Coin Chute Assembly	622,052,20x.x3	Same
7	Cotter Pin (Offset Head)	A007-1	Same
8	Cam, Coin Return	W329	Same
9	Coin Return Cam Shaft	800,502,96x.x1	Same
10	Spacer, Unified ¼” Long	801,903,69x.x1	Same
11	Coin Return Cup	801,810,14x.x1	Same
12	Change Cup Extension	491,011,16x.x3	Same
13	Keypad, Cable Clamp Kit (not shown)	D114	Same
14	Validator Filler Plate (All Dixie-Narco build doors)	360,050,72x.x3	Same
15	Gasket, Validator Filler Plate	902,001,11x.x1	Same
16	Coin Insert Label – Service Door Bezel Large	803,902,72x.x1	Same
17	IR Capable Display Harness	804,919,99x.x1	Same
18	Assembly, Coin Return Lever	800,502,98x.x1	Same
19	Coin Return Lever Limiter	801,305,22x.x1	Same
Part numbers & descriptions are subject to change with out notice. NA = Not applicable TBD = To be determined			

# PARTS LIST AND DIAGRAMS

## SERVICE DOOR (INSIDE - B)

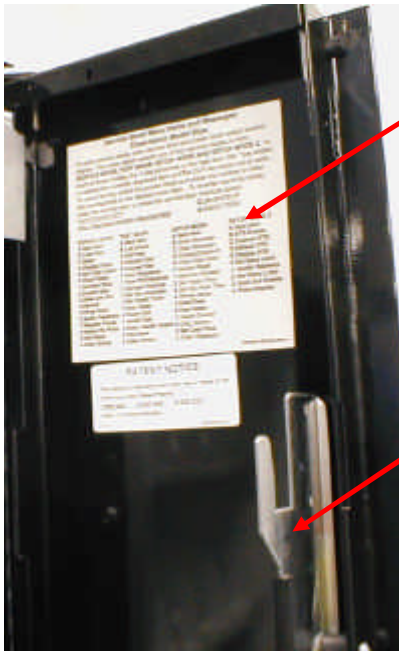

12

2

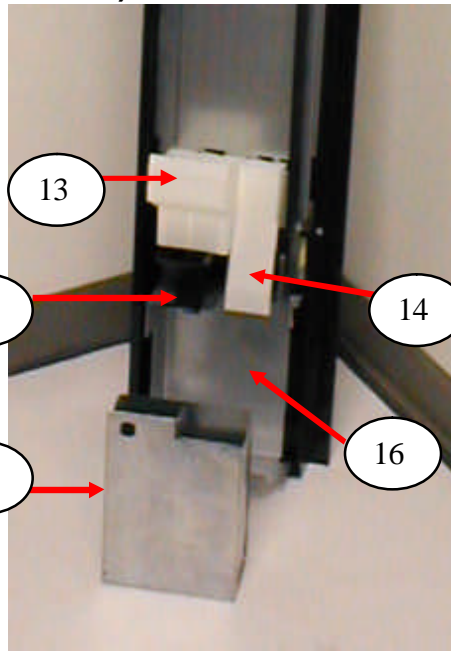

13

17

15

14

16



20

7

4

5

8



11



# PARTS LIST AND DIAGRAMS

## SERVICE DOOR (INSIDE - B)

ITEM	PART DESCRIPTION	DN59##	DN33##
1	Spacer, 10-32 .31 OD .6252L – 3 Point Lock	F557	Same
2	Latch Bar – 3 Point Lock	800,503,31x.x1	Same
	Bottom Latch – 3 Point Lock	801,305,58x.x1	Same
3	Phillips Trusshead Screw #10-32x3/8	900,201,87x.x1	Same
4	Latch Spacer – 3 Point Lock	F240-3	Same
5	Washer, Flat .191 ID .50 OD	900,701,10x.x1	Same
6	Washer, Flat .260 ID x .687 OD	900,701,22x.x1	Same
7	Screw, Shoulder 10-32x1/4	900,202,03x.x1	Same
8	Latch, Pawl – 3 Point Lock	801,518,05x.x1	Same
9	Latch, Rod – 3 Point Lock	627,050,04x.x3	Same
10	Protective Strip, Plastic (2 piece)	801,810,07x.x1	Same
11	Keypad Cable Clamp	D588	Same
	Keypad Cable Clamp Kit	D114	Same
12	Service Menu Label DN	803,853,26x.x1	Same
13	Hopper and Coin Chute	801,806,58x.x1	Same
14	Coin Chute Front	801,806,59x.x1	Same
15	Cash Box	432,051,80x.x3	Same
16	Cash Box Clip	801,814,68x.x1	Same
17	Cash Box Shelf	627,050,37x.x3	Same
18	Locking Cash Box Kit	432,011,50x.x4	Same
19	Change Cup	801,810,14x.x1	Same
20	Coin Mech Label	803,853,25x.x1	Same
	Part numbers & descriptions are subject to change with out notice. NA = Not applicable TBD = To be determined		

# PARTS LIST AND DIAGRAMS

## TALL GATE TRAY DETAIL

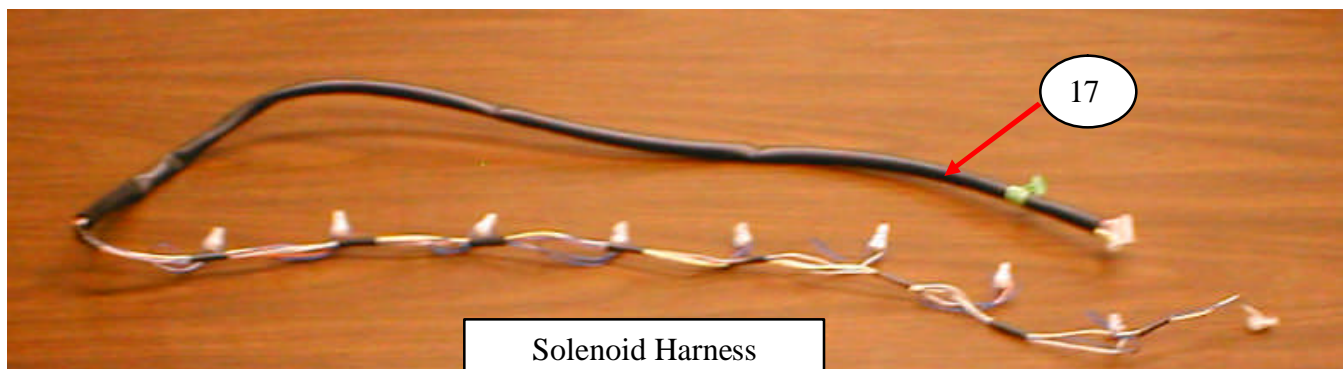
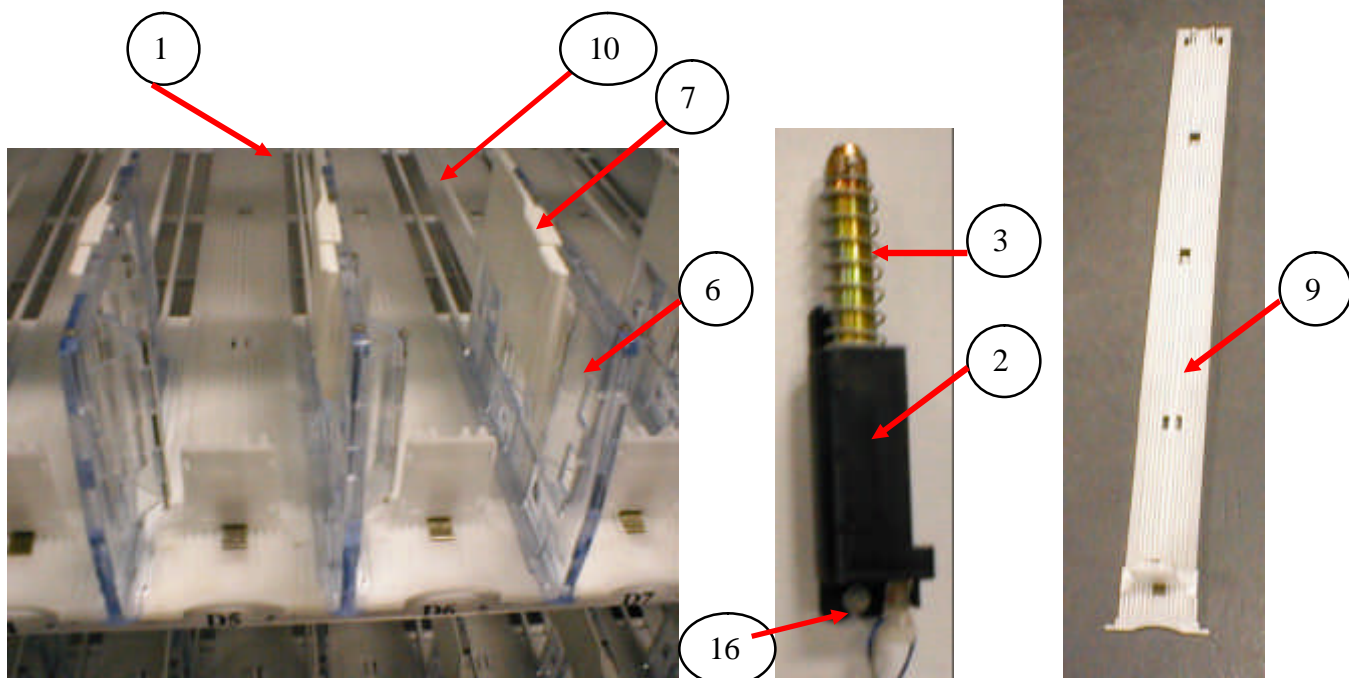



# PARTS LIST AND DIAGRAMS

## TALL GATE TRAY DETAIL

ITEM	PART DESCRIPTION	DN59##	DN33##
1	Tray Assy., 9 Column	627,070,80x.x3	635,070,00x.x3
2	Solenoid, 24 Volt w/ Plunger and Spring Assembly Kit	622,052,60x.x4	Same
3	Plunger and Spring	801,521,07x.x1	Same
4	Body	804,300,16x.x1	Same
5	Chassis Tray, Tall Gate	626,070,09x.x3	635,070,01x.x3
6	Gate Assy., w/ Kicker	801,903,83x.x1	Same
7	Spacers (also refer to TB 514)		
7A	Spacer, Tall Gate 3/16" (.155)	801,813,63x.x1	Same
7B	Spacer, Tall Gate, 3/8" (.340)	801,813,62x.x1	Same
7C	Spacer, Tall Gate (150 / 70)	801,812,02x.x1	Same
7D	Spacer "A" (210 / 70)	801,812,69x.x1	Same
7E	Spacer (340 / 210)	801,812,98x.x1	Same
7F	Spacer "B" (90 / 70)	801,812,81x.x1	Same
7G	Spacer (340 / 210 / 777) was 801,813,53x.x1	801,817,39x.x1	Same
7H	Spacer (340 / 590)	801,813,71x.x1	Same
7I	Spacer (155 / 530)	801,813,78x.x1	Same
7J	Spacer (155 / 405) was 801,813,76x.x1	801,817,38x.x1	Same
7K	Spacer Rail Assembly (metal) was 622,053,10x.x3	801,815,36x.x1	Same
7L	Product Pusher Rail	801,811,09x.x1	Same
8	Cotter Pin	W789	Same
9	Slide with Product Pusher Assy (8054 and up) (Tall Gate Only)	801,818,14x.x1	Same
	Product Pusher Spring	801,701,13x.x1	Same
10	Tray Wire, Formed Domestic 9 Column DN59##	801,401,98x.x1	801,402,21x.x1
11	Bracket, Side Tray	622,070,04x.x3	Same
12	Plastic Tray Cap	W834	Same
13	Washer, Retainer	W398	Same
14	Washer, Solenoid Retainer	801,813,06x.x1	Same
15A	Stabilizer "C" Tray (Short)	801,903,63x.x1	Same
15B	Stabilizer "D" Tray (Long)	801,903,64x.x1	Same
15C	Stabilizer, Special	801,903,85x.x1	Same
16A	Screw, Hex Washer 4-24x3/4 (Gate assy screw)	800,303,64x.x1	Same
16B	3/16" Socket, 1/4" Drive	800,102,52x.x1	Same
17	Tray Harness	804,913,74x.x1	804,920,34x.x1
Part numbers & descriptions are subject to change with out notice. NA = Not applicable TBD = To be determined			

# PARTS LIST AND DIAGRAMS

## SNACK TRAYS / HELIX

---

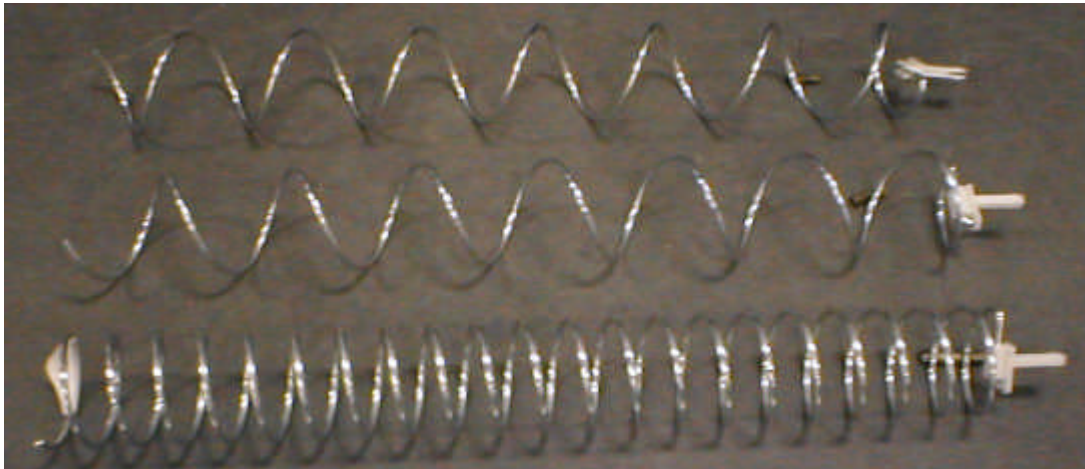
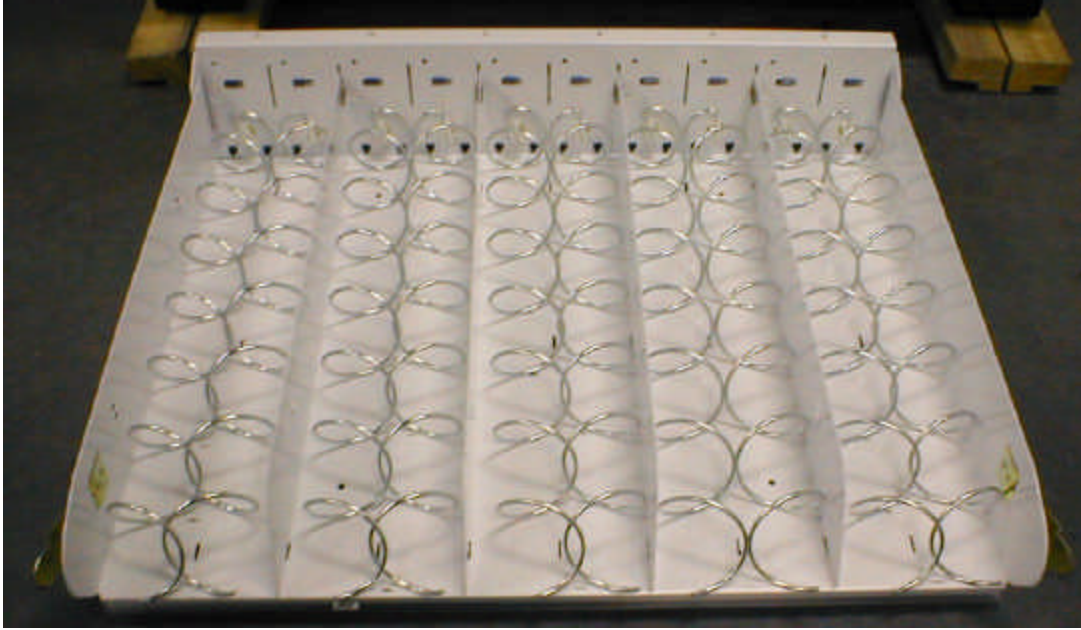

# PARTS LIST AND DIAGRAMS

## SNACK TRAYS / HELIX

ITEM	PART DESCRIPTION	DN59##	DN33##
1	Tray Assembly 5 Column/7 Count, Kit Option A	645,072,10x.x4	NA
	Tray Assembly 5 Column/13 Count, Kit Option C	645,072,00x.x4	NA
	Tray Assembly 5 Column/17 Count, Kit Option D	645,073,50x.x4	NA
	Tray Assembly 2 Column/13 Count, 3 Column/17 Count, Kit Option E	647,073,40x.x4	NA
	Tray Assembly 5 Column/11 Count, Kit Option B	645,073,30x.x4	NA
	Tray Assembly 10 Column/20 Count, Kit Option G	645,071,80x.x4	NA
	Tray Assembly 4 Column/17 Count, 6 Column/20 Count, Kit Option H	645,073,80x.x4	NA
	Tray Assembly 4 Column/17 Count, 4 Column/28 Count, 2 Column/ 20 Count, Kit Option I	645,071,70x.x4	NA
	Tray Assembly 10 Column/7 Count, Kit Option F	645,071,90x.x4	NA
2	Tray Assembly 3 Column/13 Count, Kit Option L	NA	645,073,00x.x4
	Tray Assembly 3 Column/17 Count, Kit Option M	NA	645,072,50x.x4
	Tray Assembly 1 Column/13 Count, 2 Column/17 Count, Kit Option N	NA	645,073,10x.x4
	Tray Assembly 3 Column/11 Count, Kit Option K	NA	645,073,20x.x4
	Tray Assembly 3 Column/7 Count, Kit Option J	NA	645,072,40x.x4
	Tray Assembly 6 Column/20 Count, Kit Option P	NA	645,072,20x.x4
	Tray Assembly 3 Column/17 Count, 3 Column/20 Count, Kit Option Q	NA	645,072,30x.x4
	Tray Assembly 3 Column/17 Count, 3 Column/28 Count, Kit Option R	NA	645,073,60x.x4
	Tray Assembly 6 Column/7 Count, Kit Option O	NA	645,073,70x.x4
3	Helix (Spirals)		
	28 Count Right Hand	801,701,35x.x1	Same
	28 Count Left Hand	801,701,36x.x1	Same
	20 Count Right Hand	801,701,48x.x1	Same
	20 Count Left Hand	801,701,49x.x1	Same
	17 Count Right Hand	801,701,26x.x1	Same
	17 Count Left Hand	801,701,27x.x1	Same
	13 Count Right Hand	801,701,37x.x1	Same
	13 Count Left Hand	801,701,38x.x1	Same
	11 Count Right Hand	801,701,28x.x1	Same
	11 Count Left Hand	801,701,29x.x1	Same
	10 Count Right Hand	801,701,39x.x1	Same
	10 Count Left Hand	801,701,41x.x1	Same
	9 Count Right Hand	801,701,42x.x1	Same
	9 Count Left Hand	801,401,43x.x1	Same
	8 Count Right Hand	801,701,44x.x1	Same
	8 Count Left Hand	801,701,45x.x1	Same
	7 Count Right Hand	801,701,31x.x1	Same
	7 Count Left Hand	801,701,32x.x1	Same
	6 Count Right Hand	801,701,46x.x1	Same
6 Count Left Hand	801,701,47x.x1	Same	
Part numbers & descriptions are subject to change with out notice. NA = Not applicable TBD = To be determined			

# PARTS LIST AND DIAGRAMS

## SNACK TRAY DETAIL

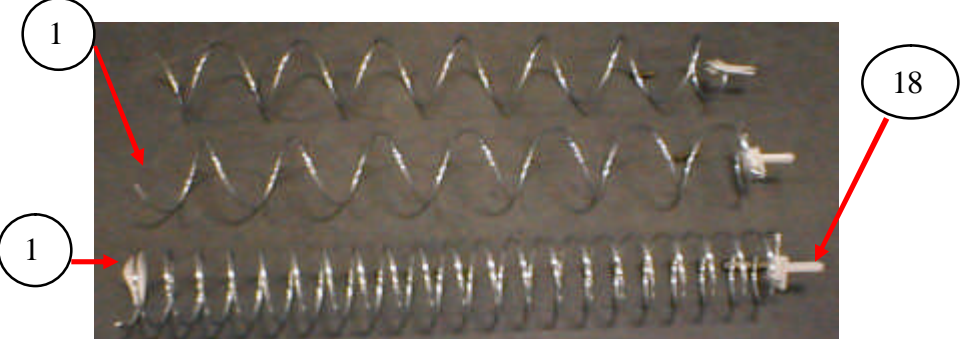
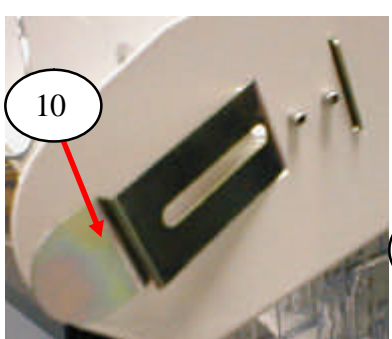
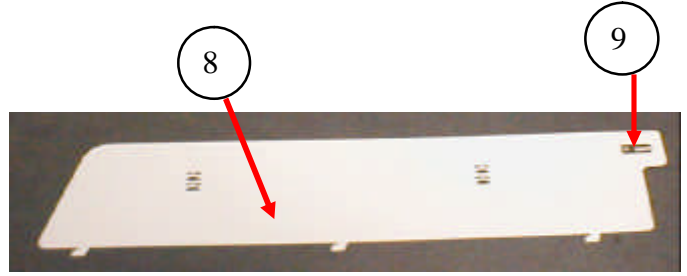
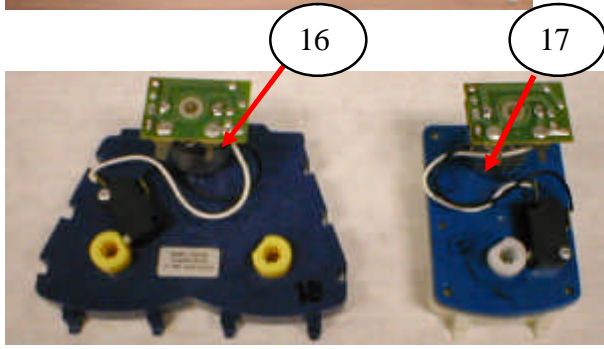
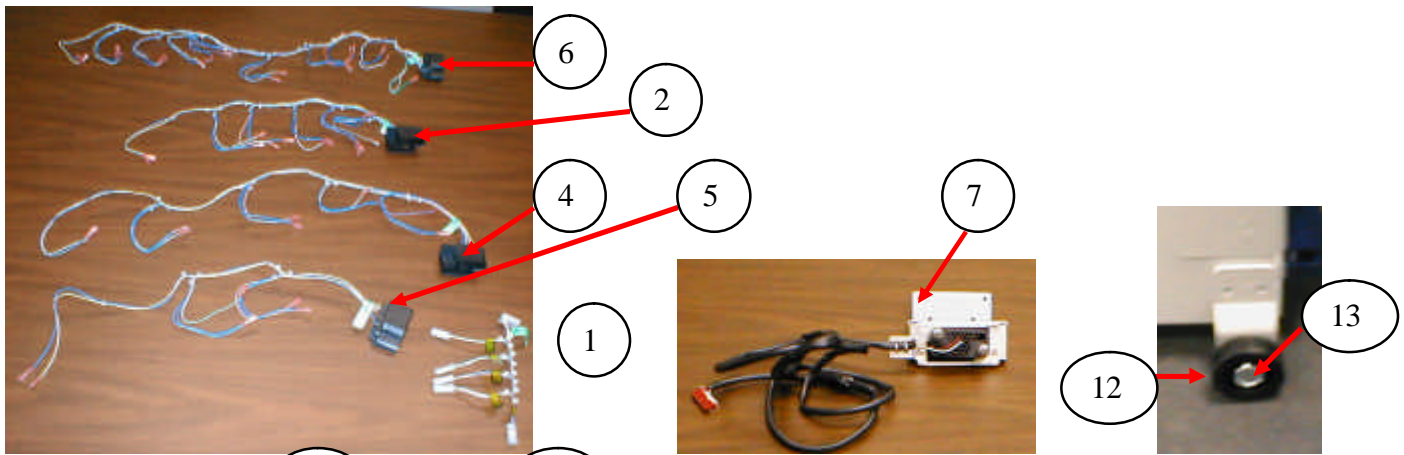
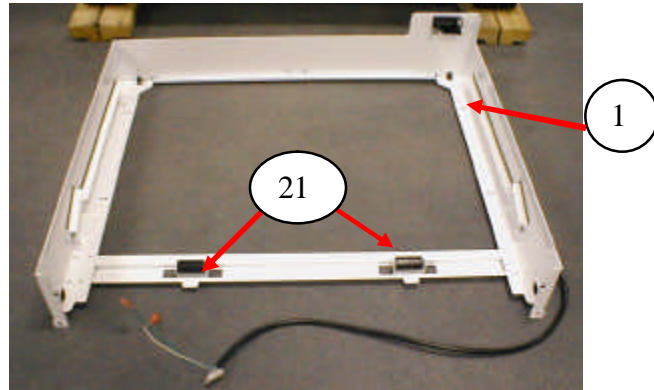

# PARTS LIST AND DIAGRAMS

## SNACK TRAY DETAIL

ITEM	PART DESCRIPTION	DN59##	DN33##
1	Frame Assembly	645,070,00x.x3	
2	Motor Harness 10 Column	804,922,98x.x1	NA
3	Jumper 10 Motor Harness	804,923,21x.x1	NA
4	Motor Harness 5 Column	804,922,97x.x1	NA
5	Motor Harness 3 Column	NA	804,922,81x.x1
6	Motor Harness 6 Column	NA	804,922,83x.x1
7	Quick Disconnect Hardware Kit	801,516,89x.x1	Same
8	Tray Divider Assembly	645,070,80x.x3	Same
9	Divider Spring	801,701,34x.x1	Same
10	Tray Latch Clip	801,701,33x.x1	Same
11	Wide Retainer Label	801,819,42x.x1	Same
12	Tray Roller	801,810,19x.x1	
13	Shoulder Screw	800,502,88x.x1	Same
14	Standoff, Blind 8 – 32 X 1	901,001,47x.x1	Same
15	Hex Nut ¼ - 20	900,800,67x.x1	Same
16	Motor, Double Helix	804,501,31x.x1	Same
17	Motor, Single Helix	804,501,29x.x1	Same
18	Adapter, Helix to Motor	801,810,21x.x1	Same
19	Spacer Bar Pivot Rod	801,401,78x.x1	Same
20	Spacer Bar	801,819,37x.x1	Same
21	Frame Roller	901,806,20x.x1	Same
22	Roller Pin	900,502,19x.x1	Same
23	Retainer Roller Pin	900,900,90x.x1	Same
Part numbers & descriptions are subject to change with out notice. NA = Not applicable TBD = To be determined			

# PARTS LIST AND DIAGRAMS

## DOMESTIC AC DISTRIBUTION BOX, 110 VAC

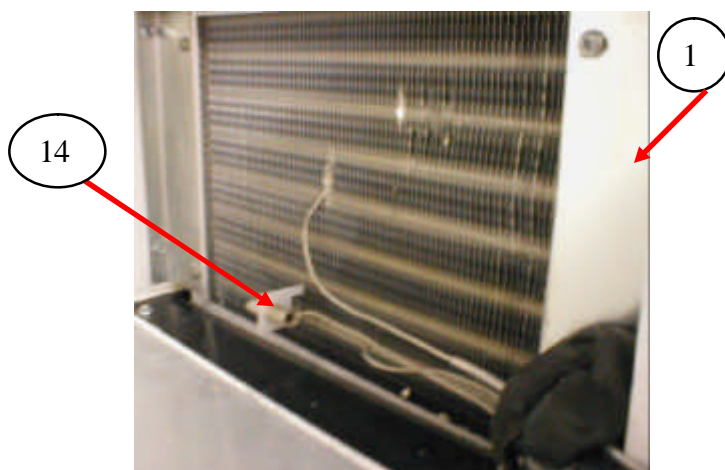
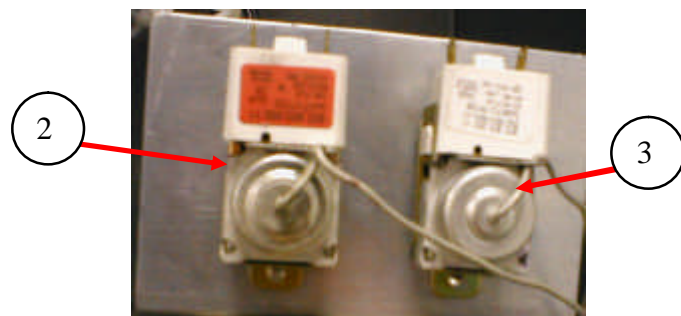
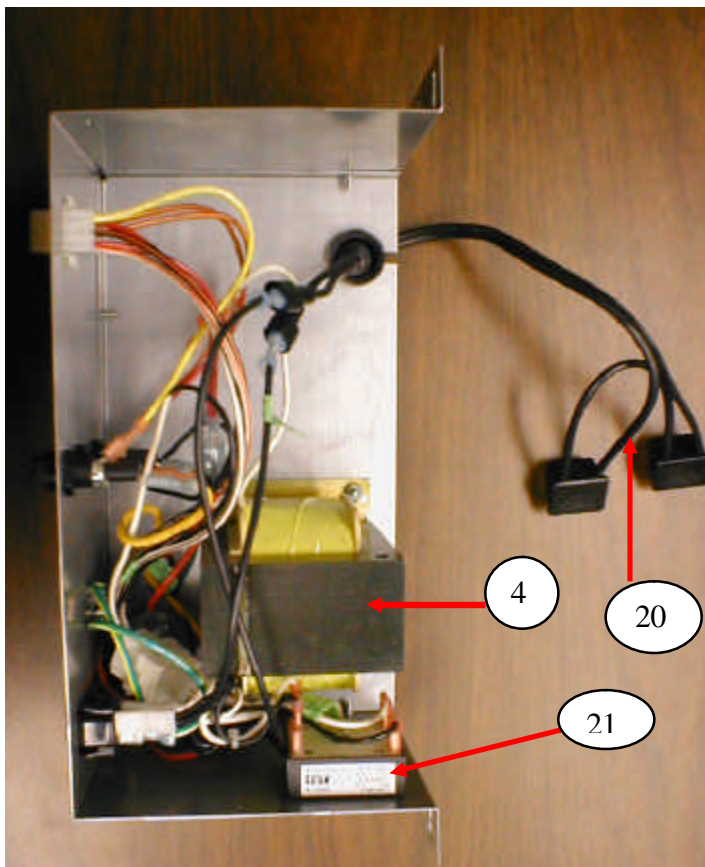
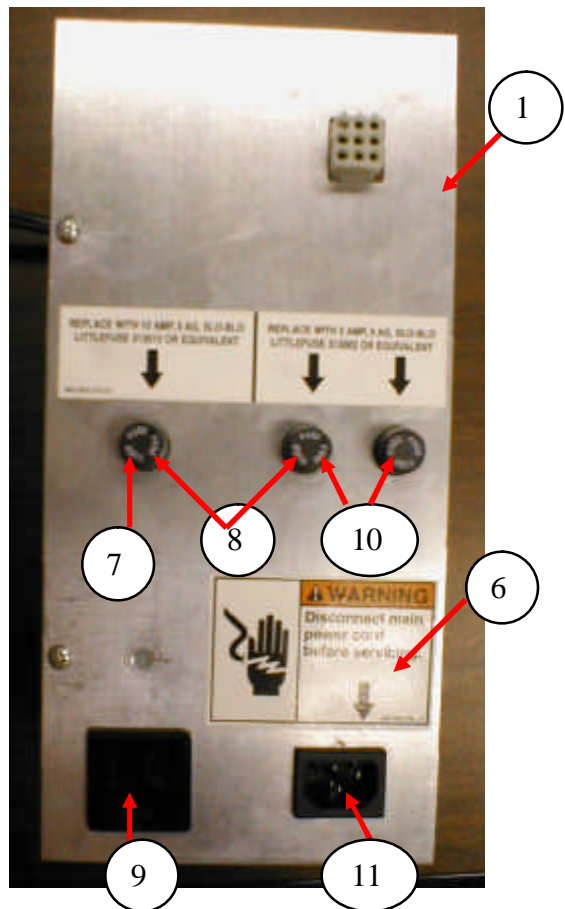

# PARTS LIST AND DIAGRAMS

## DOMESTIC AC DISTRIBUTION BOX, 110 VAC

ITEM	PART DESCRIPTION	DN59##	DN33##
1	Assy. AC Distribution T8 Electronic GFV	635,060,30x.x3	Same
2	Defrost Thermostat GE (for dual control)	802,800,60x.x1	Same
3	Cold Control GE (for dual control)	802,800,66x.x1	Same
4	Transformer, 120V / 24V, 60 Hz, 8A Domestic	804,915,54x.x1	Same
5	2 Amp Fuse / 10 Amp Fuse Label	803,853,21x.x1	Same
6	Label, Electrical Box, "WARNING – Disconnect Main Power Cord Before Servicing"	803,853,22x.x1	Same
7	Fuse, 10 Amp, 32V SloBlo	W659	Same
8	Fuse Holder, Panel Mounted, Quick Disconnect	804,920,02x.x1	Same
9	Outlet, 15 Amp, Grounded	W662	Same
10	Fuse, 2 Amp, 250V, SloBlo	W658	Same
11	Power Inlet Plug	804,913,62x.x1	Same
12	Dual Temperature Control Bracket	622,060,13x.x3	Same
13	Temperature Control Label	803,847,08x.x1	Same
14	Temperature Control Clip	800,902,63x.x1	Same
15	Harness, AC Power Choke Input	804,920,56x.x1	Same
16	Harness, AC Distribution Box Power	804,920,48x.x1	Same
17	Harness, Choke Output	804,920,49x.x1	Same
18	Harness, MDB Interior Power T8/Electronic GFV	804,920,55x.x1	Same
19	Harness, Main Power	804,913,77x.x1	Same
20	Harness, Dual Thermostat	804,914,39x.x1	Same
21	Choke	804,920,41x.x1	Same
Part numbers & descriptions are subject to change with out notice. NA = Not applicable TBD = To be determined			

# PARTS LIST AND DIAGRAMS

## LIGHTING

ITEM	PART DESCRIPTION	DN59##	DN33##
1	Ballast Assembly, 110 Volt/60 Hertz	804,400,54x.x1	Same
2	Ballast Assembly, 220 Volt/50 Hertz	TBD	Same
3	Lens, Fluorescent Lamp Assembly	801,904,15x.x1	Same
4	Fluorescent Lamp 40 Watt, 48"	804,700,65x.x1	Same
5	Light Harness, 120 Volt	804,913,78x.x1	Same
6	Lamp Holder Assembly	622,060,20x.x3	Same
7	Light Installation Assembly	622,060,30x.x3	Same
Part numbers & descriptions are subject to change with out notice. NA = Not applicable TBD = To be determined			

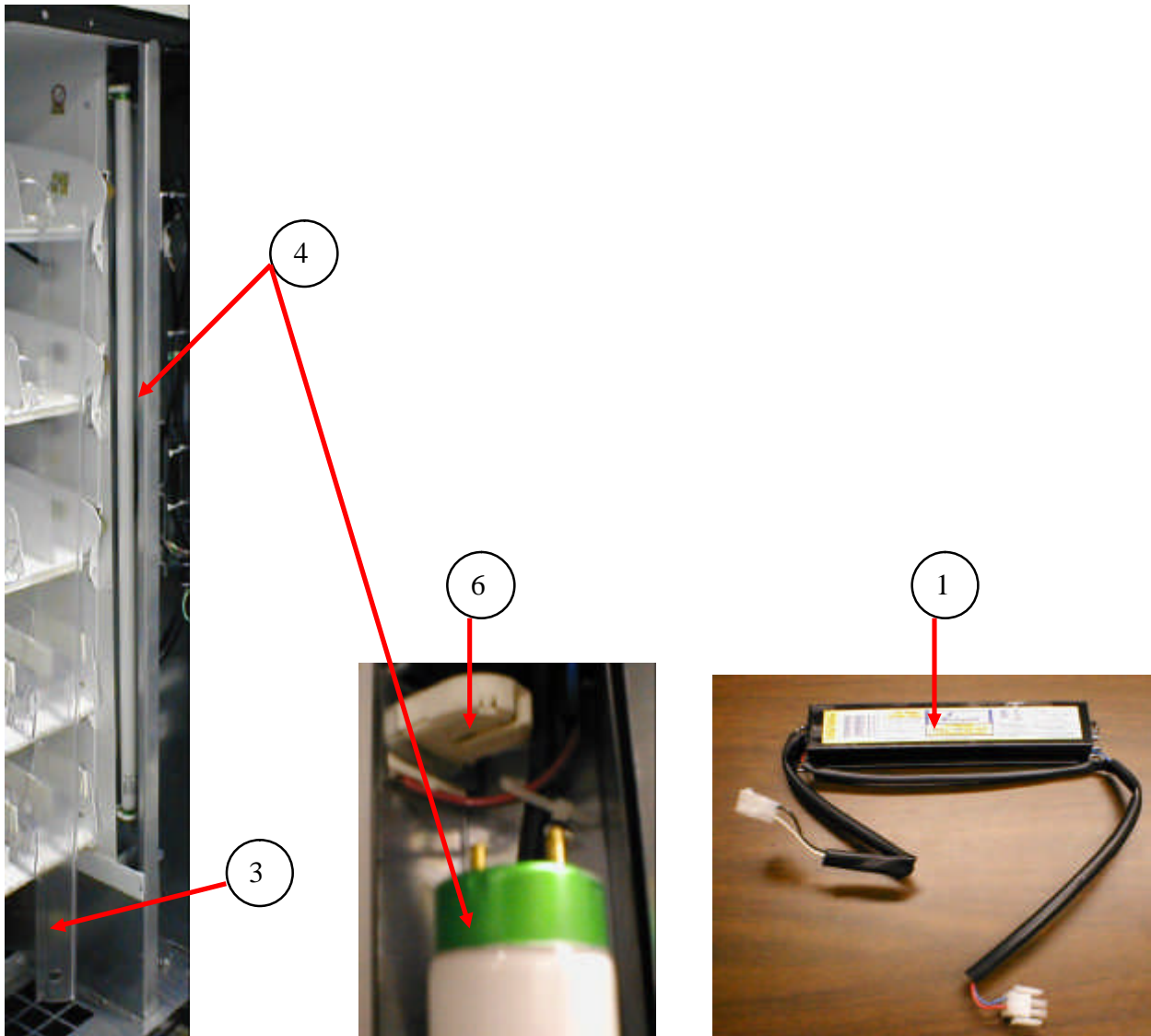



# PARTS LIST AND DIAGRAMS

## REFRIGERATION UNIT (DN 59##/33## FIN & TUBE CONDENSER)

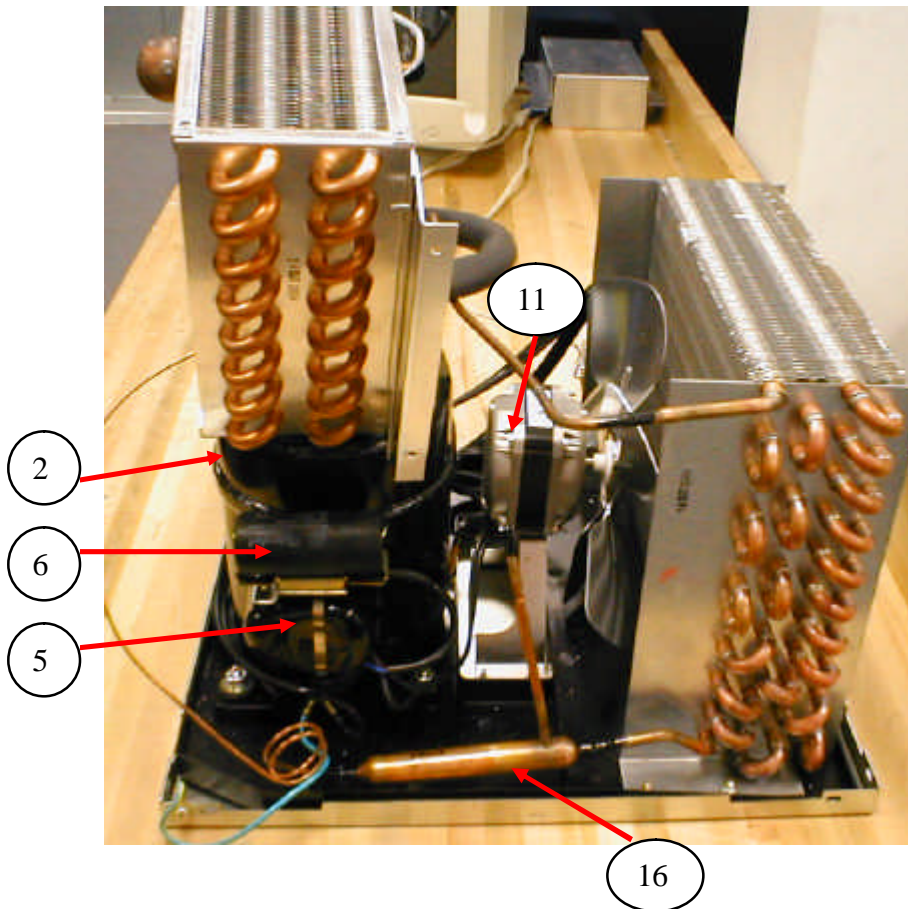
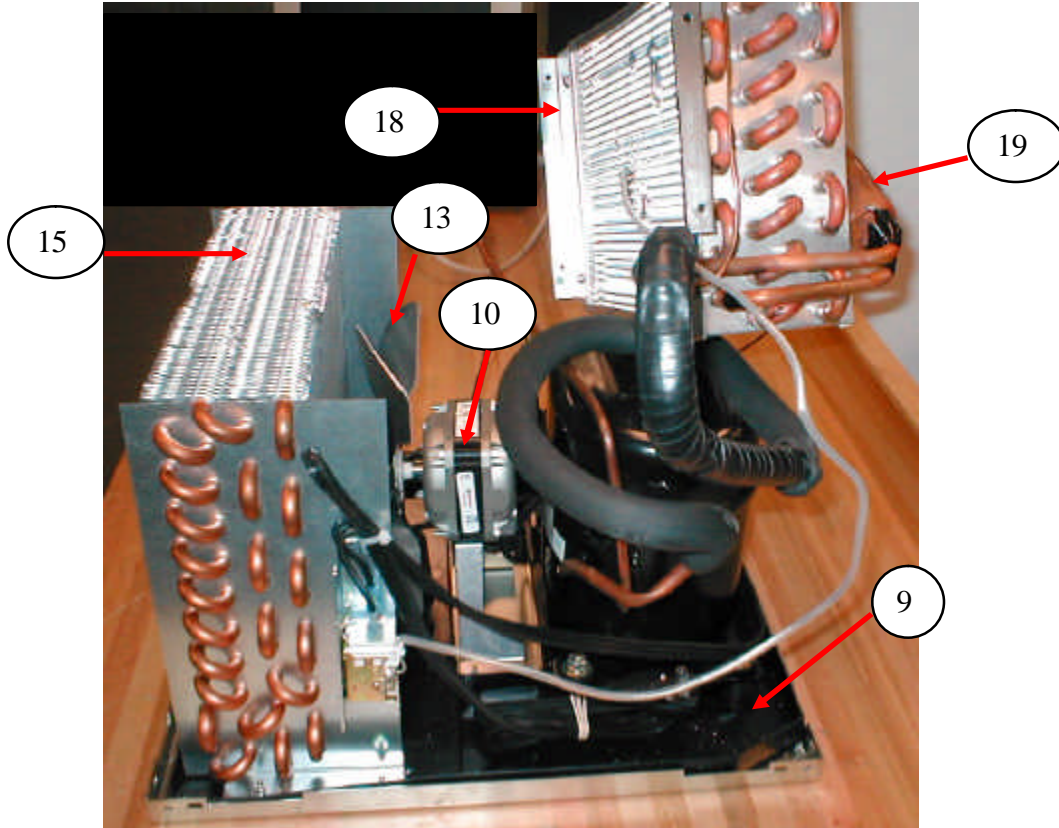

# PARTS LIST AND DIAGRAMS

## REFRIGERATION UNIT (DN 59##/33## FIN & TUBE CONDENSER)

ITEM	PART DESCRIPTION	DN59##	DN33##
1A	Refrigeration Unit EM2001 C-A Kit, 115V/60Hz Domestic Kit	635,040,00x.x4	Same
1B	Refrigeration Unit EM2001 C-A, 115V/60Hz Domestic		Same
2	Compressor Assy. 115V/60Hz Domestic	TBD	Same
2A	Compressor, Domestic	TBD	Same
2B	Compressor, Export	TBD	Same
3A	Overload, 115V Domestic	TBD	Same
3B	Overload, 220V Export	TBD	Same
4A	Relay, 110V –Domestic	TBD	Same
4B	Relay, 220V –Export	TBD	Same
5	Cover, Overload/Relay Tecumseh	TBD	Same
6A	Start Capacitor, 110V – Domestic	TBD	Same
6B	Start Capacitor, 250V/50Hz Export	TBD	Same
7	Start Capacitor, End Cap Bottom Hole	TBD	Same
8	Bracket, Capacitor Assembly	TBD	Same
9A	Drain Pan, Condensate - Domestic	TBD	Same
9B	Drain Pan, Condensate - Export	TBD	Same
10A	Assembly Condenser Fan, 10" Domestic	TBD	Same
10B	Assembly Condenser Fan , 220V Export	TBD	Same
11A	Condenser Fan Motor, Domestic	TBD	Same
11B	Condenser Fan Motor, Export	TBD	Same
12	Silencer	TBD	Same
13	Fan Blade, Condenser	TBD	Same
14	Speed Nut	TBD	Same
15	Condenser	TBD	Same
16	Dryer	TBD	Same
17	Grommet Compressor	TBD	Same
18	Evaporator	TBD	Same
19	Accumulator	TBD	Same
Part numbers & descriptions are subject to change with out notice. NA = Not applicable TBD = To be determined			

# PARTS LIST AND DIAGRAMS

## ELECTRONICS

ITEM	PART DESCRIPTION	DN59##	DN33##
1	Entry Control Board	TBD	Same
2	EPROM, Firmware Entry	804,917,93x.x1	Same
3	Display Assembly	804,919,95x.x1	Same
4	Display, 14 Segment Character	804,912,79x.x1	Same
5	Transformer	804,915,54x.x1	Same
6	Fuse, AC Distribution Box – 10 Amp SloBlow	W659	Same
7	Fuse, AC Distribution Box – 2 Amp, 250 Volt SloBlow	W658	Same
8	Battery, 3 Volt Lithium	804,920,45x.x1	Same
9	Vend Sensor Kit	TBD	Same
10	Temp Sensor	804,917,24x.x1	Same
11	Temp Sensor Control Board	804,916,29x.x1	Same

Part numbers & descriptions are subject to change with out notice.

NA = Not applicable

TBD = To be determined

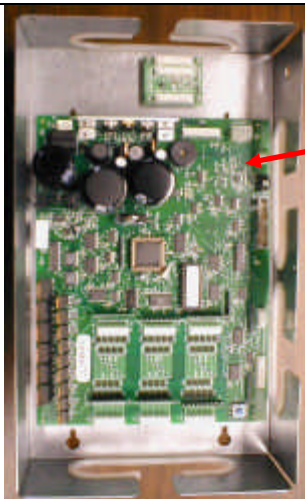

1

2

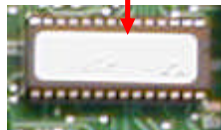

3

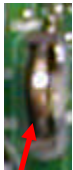
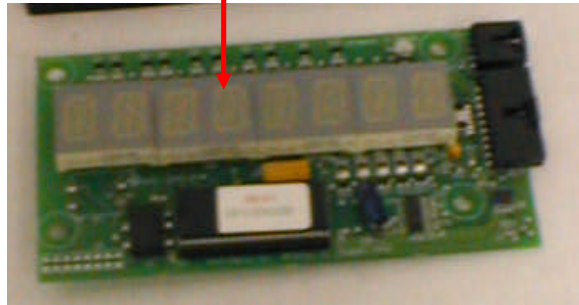

8



9

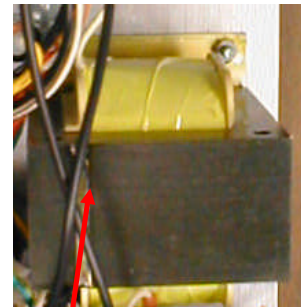

5

# PARTS LIST AND DIAGRAMS

## HARNESSES

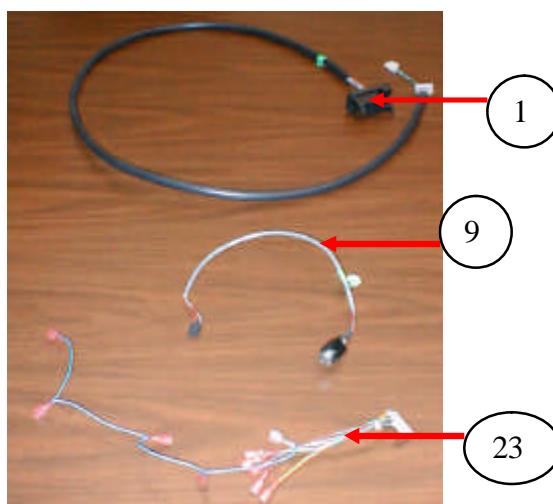
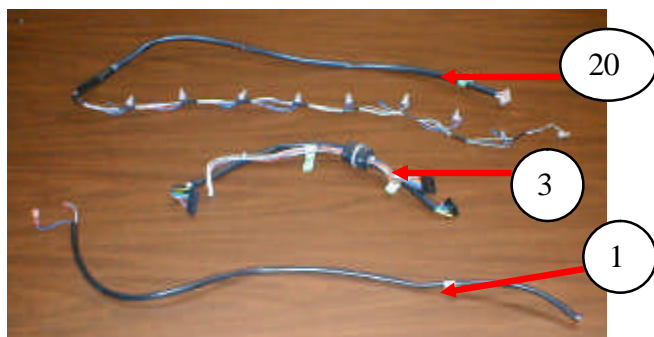
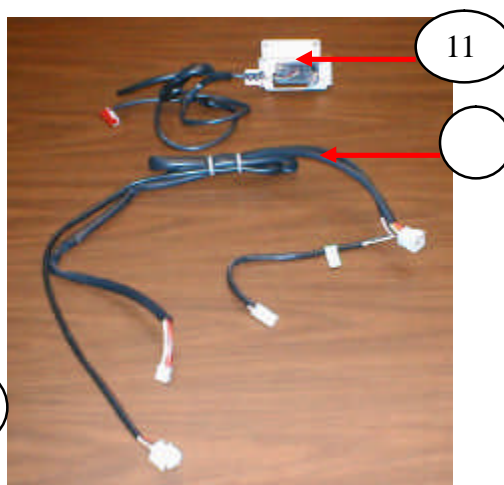
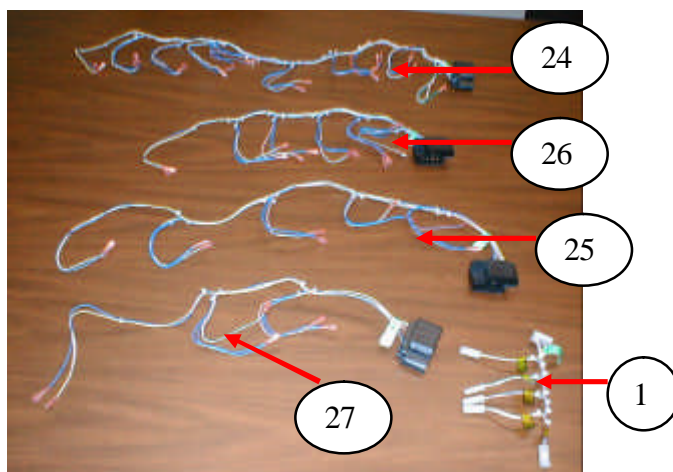

# PARTS LIST AND DIAGRAMS

## HARNESSES

ITEM	PART DESCRIPTION	DN59##	DN33##
1	Harness, Controller Board to Door Switch	804,918,24x.x1	Same
2	Harness, Power to Controller Board	804,913,75x.x1	Same
3	Harness, Controller Board to Keypad	804,913,69x.x1	Same
4	Harness, Controller Board to Display	804,919,99x.x1	Same
5	Harness, Light GFV 120V	804,920,51x.x1	Same
6	Harness, MDB Coin Mech 16"	804,920,25x.x1	Same
7	Harness, Main Power	622,060,60x.x3	Same
8	Harness, DEX 66 '	804,907,83x.x1	Same
9	Harness, DEX 15"	804,913,97x.x1	Same
10	DEX Kit – Includes bracket, 15" harness, & hardware	627,020,30x.x4	Same
11	Harness, Cabinet Vend Sensor Entray	804,923,15x.x1	Same
12	Harness, Vend Sensor	804,923,22x.x1	Same
13	Harness, Connector Frame	804,922,96x.x1	Same
14	Harness, Recovery Unit	804,923,16x.x1	Same
15	Harness, AC Power Choke Input	804,920,56x.x1	Same
16	Harness, AC Box Power Distribution	804,920,48x.x1	Same
17	Harness, Jumper AC Refrigeration	804,913,79x.x1	Same
18	Harness, Choke Output	804,920,49x.x1	Same
19	Harness, Interior Power T8 Electronic	804,920,55x.x1	Same
20	Harness, Tray	804,913,74x.x1	Same
21	Harness, Thermostat Dual	804,914,39x.x1	Same
22	Cable, Temp Sensor	804,917,24x.x1	Same
23	Harness, Jumper 10 Motor	804,923,21x.x1	NA
24	Harness, Motor 10 Column	804,922,98x.x1	NA
25	Harness, Motor 5 Column	804,922,97x.x1	NA
26	Harness, Motor 6 Column	NA	804,922,83x.x1
27	Harness, Motor 3 Column	NA	804,922,81x.x1
Part numbers & descriptions are subject to change with out notice. NA = Not applicable TBD = To be determined			

# PARTS LIST AND DIAGRAMS

## LABELS / DECALS / MISC.

ITEM	PART DESCRIPTION	DN59##	DN33##
1	Vender Lag Bracket Kit	627,020,60x.x4	Same
2	Wall Stand-Off Bracket Kit	D014	Same
3	DEX Kit – Includes bracket, 15” harness, & hardware	627,020,30x.x4	Same
4	Thermometer	801,401,55x.x1	Same
5	Label Set, Price and Product	W485	Same
6	Label Set, Product Only (i.e. A1, A2, etc.)	W485-1	Same
7	Label, Open Bottles Slowly	803,865,09x.x1	Same
8	Label, Selection	803,857,26x.x1	Same
9	Label, Package Setup Guide	803,865,55x.x1	Same
10	Label, Warning “DO NOT TILT”	803,868,29x.x1	Same
11	Label, Programming	803,853,26x.x1	Same
12	Label, Coin Mech	803,853,25x.x1	Same
13	Label, Pricing Low - Entray	803,875,64x.x1	Same
14	Label, Pricing High - Entray	803,876,44x.x1	Same
15	Label, Selection - Entray	803,875,65x.x1	Same
16	Label, Common Package Spacer Set Up	803,869,97x.x1	Same
17	Label, Coin Return Service Door Bezel	803,857,25x.x1	Same
18	Label, AC Distribution Box Power Disconnect	803,853,22x.x1	Same
19	Label, Coin Insert Service Door Bezel	803,902,72x.x1	Same
20	Decal, Side, Cabinet	TBD	Same
21	Decal , Top Glass Door	TBD	Same
22	Decal, Bottom Glass Door	TBD	Same
23	Product Pusher Flavor Card Sheet Pepsi Domestic 1	803,862,39x.x1	Same
24	Product Pusher Flavor Card Sheet Pepsi Domestic 2	803,862,40x.x1	Same
25	Product Pusher Flavor Card Sheet Generic Domestic 1	803,862,41x.x1	Same
26	Product Pusher Flavor Card Sheet Generic Domestic 2	803,862,42x.x1	Same
27	Product Pusher Flavor Card Sheet Coke Domestic 1	803,862,37x.x1	Same
28	Product Pusher Flavor Card Sheet Coke Domestic 2	803,862,38x.x1	Same
29	Manual, Service / Operation / Parts	803,904,03x.x1	Same
Part numbers & descriptions are subject to change with out notice. NA = Not applicable TBD = To be determined			

# PARTS LIST AND DIAGRAMS

## SCREWS & NUTS

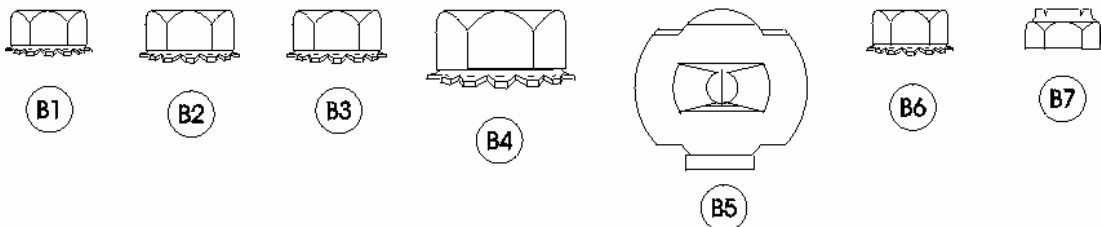
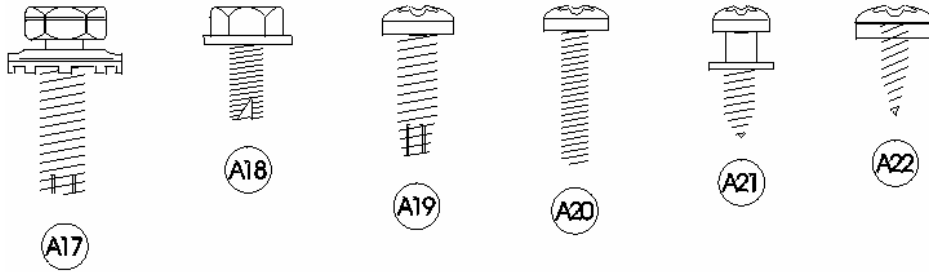
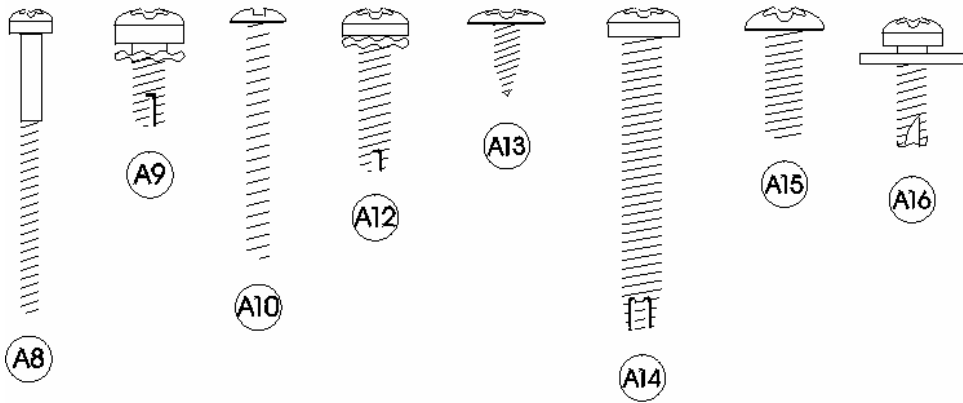
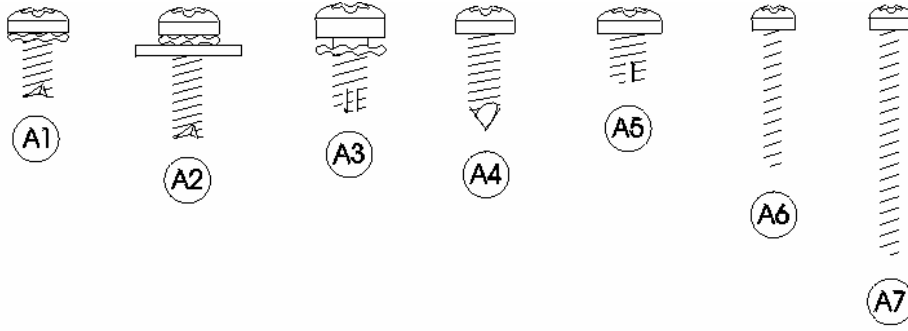

# PARTS LIST AND DIAGRAMS

## SCREWS & NUTS

ITEM	PART NUMBER	PART NAME AND DESCRIPTION
A1	900,301,70x.x1	Screw, Phil Pan Swage Form #6 - 32 x 3/8"
A2	900,301,64x.x1	Screw, Phil Pan Swage Form w/washer #8 - 32 x 1/2"
A3	900,301,83x.x1	Screw, Phil Pan Swage Form #10 - 32 x 5/16"
A4	900,301,50x.x1	Screw, Phil Pan w/out washer, #8 - 18 x 1/2"
A5	900,301,97x.x1	Screw, Phil Pan Swage Form #8 - 32 x 1/4"
A6	900,300,47x.x1	Screw, Vend Motor, #4-24 x 3/4" Single Switch (NOT USED)
A7	900,301,82x.x1	Screw, Vend Motor, #4-24 x 1 1/16" Double Switch (NOT USED)
A8	900,301,61x.x1	Screw, Vend Motor, #4-24 x 1 1/2" Triple Switch (NOT USED)
A9	900,301,56x.x1	Screw, Phil Pan Cutting #8 - 32 x 3/8"
A10	900,201,31x.x1	Screw, Machine, #6 - 32 x 1 1/4"
A11	900,301,97x.x1	Screw, Phil Pan Sems #8 - 32 x 1/4"
A12	900,301,85x.x1	Screw, Phil Thread Form #8 - 32 x 5/8"
A13	900,300,16x.x1	Screw, Phil Head Truss #6 x 3/8"
A14	900,301,81x.x1	Screw, Phil Pan Form #10 - 32 x 1 1/4"
A15	900,201,14x.x1	Screw, Machine Truss, #10 - 32 x 1/2"
A16	900,301,65x.x1	Screw, Phil Pan Sems with washer, #8 - 18 x 1/2"
A17	900,302,01x.x1	Screw, Self Tapping, 1/4 - 20 x 5/8"
A18	900,301,69x.x1	Screw, Hex Head Swage Form #8 - 36 x 3/8"
A19	900,901,51x.x1	Screw, Phil Pan Tapping #10 - 32 x 5/8"
A20	900,201,22x.x1	Screw, Machine Phil Pan #8 - 32 x 3/4"
A21	900,301,98x.x1	Screw, Phil Pan Shoulder #8 - 18 x 1/2"
A22	900,301,84x.x1	Screw, Phil Pan #8-18x1/2"
A23	900,500,26x.x1	Shoulder Screw 1/2" Long
A24	900,201,13x.x1	Screw, Hex Head
A25	900,301,73x.x1	Screw, Tap 1/4-20x1" Type F
A26	800,303,15x.x1	Screw, Phil Pan #8-18x3/4"
A27	800,303,18x.x1	Screw, Truss Type 23 #8-32x1/2
A28	900,301,94x.x1	Screw, Phil Flat 23B #10-32x1/2"
A29	900,201,44x.x1	Screw, Machine Brass #6-32x1/4"
A30	900,301,99x.x1	Screw, Plastic 8-hi/low x 1 1/4
A31	900,301,55x.x1	Screw, Phil Pan Swage Form #8-32x1/2"
A32	900,303,08x.x1	Screw, Hex Washer Type 1 #8-32x3/8"
A34	800,303,22x.x1	Screw, Phil Pan #6-20x3/8
A35	900,302,02x.x1	Screw, Self Tapping, #8-18x3/4
A36	900,201,86x.x1	Screw, Phil Pan Head #6-32x1/4"
B1	900,800,65x.x1	Hex Nut, #10 - 32
B2	900,800,67x.x1	Hex Nut, 1/4 - 20
B3	900,800,50x.x1	Hex Nut, #8 - 32
B4	900,800,69x.x1	Hex Nut, Top Door Hinge, 3/8 - 16
B5	900,800,85x.x1	Speed Nut
B6	900,800,49x.x1	Hex Nut, #6 - 32
B7	900,800,51x.x1	Elastic Stop Nut, #8 - 32
B8	900,800,81x.x1	Hex Nut 8-32
B9	900,902,37x.x1	Push Nut, Acorn Type
B10	900,801,02x.x1	Hex Nut 5/16-18
B11	900,800,81x.x1	Hex Nut, Flange with Serrations 8-32

Part numbers & descriptions are subject to change with out notice.

NA = Not applicable



# PARTS LIST AND DIAGRAMS

## WASHERS, BOLTS, & MISC. HARDWARE

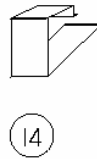
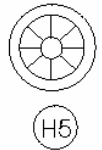
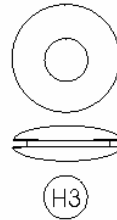
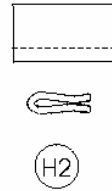
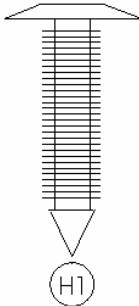
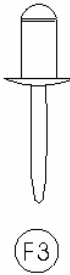
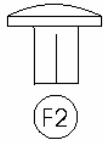
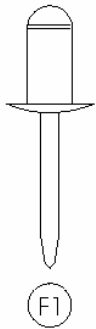
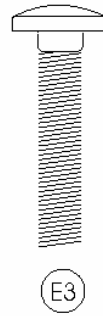
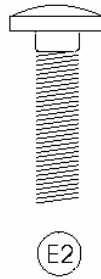
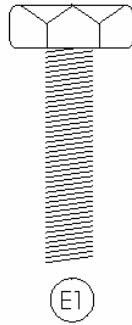
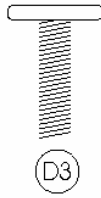
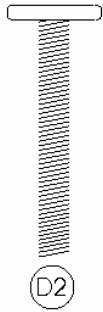
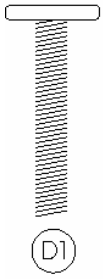
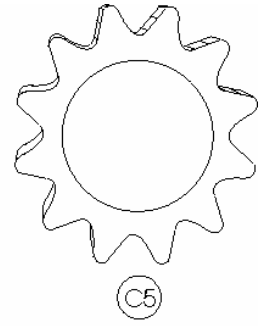
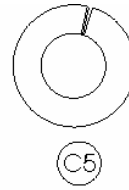
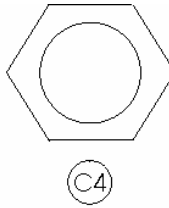
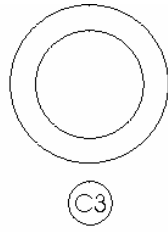
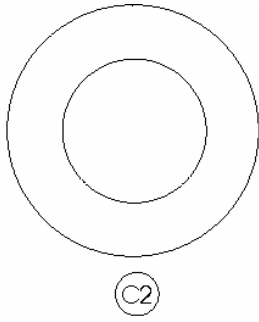
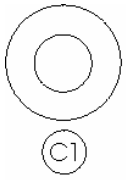

# PARTS LIST AND DIAGRAMS

## WASHERS, BOLTS, & MISC. HARDWARE

ITEM	PART NUMBER	PART NAME AND DESCRIPTION
C1	900,700,60x.x1	Washer, Delrin .047 Thick 3/8"IDx5/8"OD
C2	901,303,77x.x1	Washer, Door Hinge
C3	901,503,06x.x1	Washer, Flat #2949 (T-Handle)
C4	901,503,08x.x1	Washer, Hex #29-34 (T-Handle)
C5	900,700,36x.x1	Lockwasher, Split 3/8"
C6	900,700,89x.x1	Lockwasher, Shakeproof 5/8" (1132-00-00-0551)
C7	900,700,02x.x1	Steel Washer, 18 Gauge (1/2"x3/16")
C8	900,700,62x.x1	Washer, Shakeproof (4610-16-01-0551)
C10	900,700,83x.x1	Washer, Flat 18 Gauge (17/64"IDx5/8"OD)
C11	900,700,08x.x1	Washer, Flat 14 Gauge (5/16"-3/8"x7/8")
C12	801,902,48x.x1	Nylon Spacer
	900,701,05x.x1	Washer Flat (.343"ID x .688" OD .6T)
D1	900,400,43x.x1	T-Bolt, #8 - 32 x 1" (obsolete)
D2	900,400,41x.x1	T-Bolt, #8 - 32 x 1 3/8"
D3	900,40x.x5x.x1	T-Bolt, #8 - 32 x 3/4"
D4	900,400,45x.x1	T-Bolt, #8 - 32 x 1/2"
E1	900,400,44x.x1	Refrigeration Bolt, 3/8 - 16 x 1"
E2	900,201,17x.x1	Carriage Bolt, 1/4 - 20 x 1"
E3	900,201,23x.x1	Carriage Bolt, 1/4 - 20 x 1 1/4"
E4	900,201,45x.x1	Carriage Bolt, 1/4 - 20 x 1/2"
E5	900,201,54x.x1	Carriage Bolt, 1/4 - 20 x 3/8"
E6	900,201,56x.x1	Carriage Bolt, 1/4 - 20 x 3/4"
E7	900,303,12x.x1	Carriage Bolt, 1/4-20x5/8" (obsolete)
E8	900,201,85x.x1	Carriage Bolt, 5/16x18x1 1/4" Top Hinge (drop in)
E9	800,303,19x.x1	Carriage Bolt, 1/4-20x5/8"
E10	900,202,04x.x1	Carriage Bolt, 1/4-20x1/2" (red)
F1	901,100,43x.x1	Pop Rivet, Aluminum 1/4"
F2	901,100,44x.x1	Drive Rivet, #38-108-06-13 1/4" dia.
F4	901,100,54x.x1	Pop Rivet, Black 1/8"
F5	901,100,61x.x1	Pop Rivet, Steel (Zinc Plated) 1/8"
F6	901,100,53x.x1	Pop Rivet, Aluminum 1/8"
F7	901,100,60x.x1	Pop Rivet, Steel (Zinc Plated) 3/16"
H1	900,902,13x.x1	Christmas Tree Clip #354280307-00 (NOT USED)
H2	900,901,89x.x1	Tinnerman Clip, Fan Shroud (C5207-014-3B)
H3	900,401,09x.x1	Grommet, Bk. Rubber #97
H4	901,503,07x.x1	E-Ring #31-30
H5	900,900,90x.x1	Retainer, Roller Pin
H6	900,902,18x.x1	Tinnerman Clip
H7	801,807,01x.x1	Hole Plug, Snap in - 1 1/4
H8	901,806,77x.x1	Grommet, Admiral #B53351
H9	902,100,29x.x1	Silencer
I1	804,601,45x.x1	#6 Terminal Ring Crimp 16-14 AWG
I2	801,902,48x.x1	Nylon Spacer
I3	801,809,12x.x1	Velcro Blocks
I4	801,807,49x.x1	Vender Defender Clamp

Part numbers & descriptions are subject to change with out notice.

NA = Not applicable

# PARTS LIST AND DIAGRAMS

---

## WASHERS, BOLTS, & MISC. HARDWARE

ITEM	PART NUMBER	PART NAME AND DESCRIPTION
15	901,901,89x.x1	Clamp, Cable 1" Heyco 3390
16	900,901,79x.x1	Clamp, Nylon 5/16" Black Heyco 3355 or Dennison 10159
17	900,901,80x.x1	Clamp, Nylon 1/2" Heyco 3328
18	901,901,06x.x1	Hand Tie, x.x"
19	901,902,01x.x1	Wire Tie, 7 1/2"
10	901,901,00x.x1	Wire Ties, 4"
11	901,900,55x.x1	Clamp, Nylon 3/4" Heyco 3382BL
12	901,902,83x.x1	Cable Tie, x.x"
13	900,902,14x.x1	Canoe Clip #254-090-301-00-0108

Part numbers & descriptions are subject to change with out notice.

NA = Not applicable