



# VANTAGE™

## Bill Acceptor







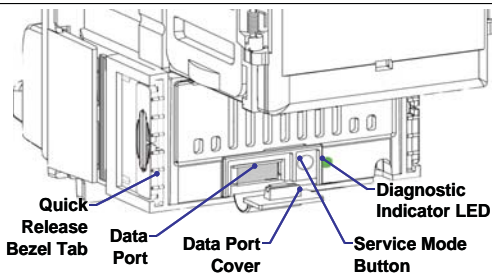
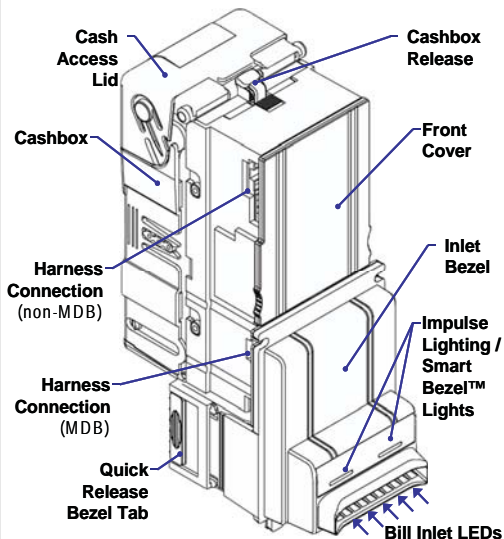

### Quick Start Guide



# Vantage™ Components



# Diagnostic Flash Codes

|                | Flash Code                                                                                | Validator Status |
|----------------|-------------------------------------------------------------------------------------------|------------------|
| Operational    |  (solid) | Sales Mode / OK  |
|                |  x 1     | Coupon Teach *   |
|                |  x 2     | Service Mode     |
| Warning        |  x 1     | Clean Unit       |
|                |  x 2     | Service Unit     |
| Out of Service |  x 1     | Cashbox Full     |
|                |  x 2     | Clear Bill Path  |
|                |  x 3   | Out of Service   |

\*: See Service Manual for more info on Coupon Teach.

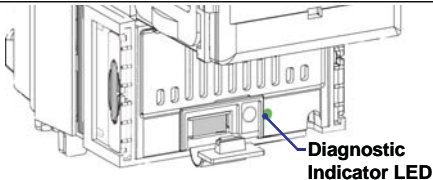

# Configuration Settings

**ON**

Inlet LED On:  
Option Enabled

**OFF**

Inlet LED Off:  
Option Disabled

Page 1

## Bill Acceptance



\$1

\$5

\$10

\$20

Page 1  
(Flash x1)

Page 2

## Coupons / Security / Bezel Lights



Coupons

High  
Security

Impulse

Smart  
Bezel™

Page 2  
(Flash x2)

Page 3

## Bill Acceptance / Orientation



1-Way 2-Way  
← 4-Way (both) →

\$50

\$100

Page 3  
(Flash x3)

Page 4

## Level 3 Security

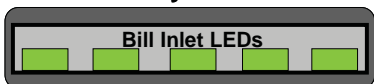





Level 3  
Security



← Reserved →

Page 4  
(Flash x4)

# To Configure Options

| #  | Action                                                                                                                      | Mode           | Diagnostic Light                                                                      |
|----|-----------------------------------------------------------------------------------------------------------------------------|----------------|---------------------------------------------------------------------------------------|
| 1. |  Hold button until Diagnostic LED flashes. | Service        |  x 2 |
| 2. | Remove Lower Housing                                                                                                        | Config         |      |
| 3. | Set Options As Desired ( <i>see Options Navigation below</i> )                                                              | Config         |      |
| 4. | Re-install Lower Housing. Inlet LEDs flash 5 times confirming options are saved.                                            | Sales or Ready |      |
| 5. | Test Unit to Ensure Proper Setup.                                                                                           |                |                                                                                       |

## Options Navigation



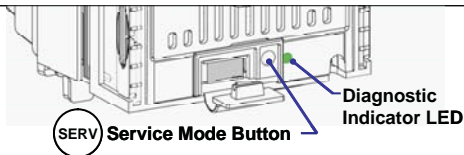



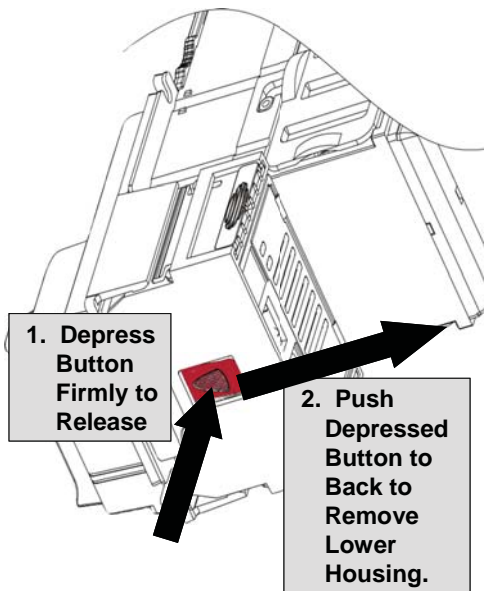



|                                                                                                        |                                                            |
|--------------------------------------------------------------------------------------------------------|------------------------------------------------------------|
|  Press once         | Scrolls to <b>next set</b> of options within current Page. |
|  Hold for next Page | Scrolls to <b>next Page</b> of options.                    |



# Lower Housing Removal



# Add / Remove Coupons

| #                                   | Action                                                                                                                                                                                                                                          | Mode         | Diagnostic Light                                                                                 | Bill Inlet LEDs                                                                                  |
|-------------------------------------|-------------------------------------------------------------------------------------------------------------------------------------------------------------------------------------------------------------------------------------------------|--------------|--------------------------------------------------------------------------------------------------|--------------------------------------------------------------------------------------------------|
| 1.                                  |  Hold button until Diagnostic LED flashes.                                                                                                                     | Coupon Teach | <br>(flash)     | <br>(flash)     |
| 2.                                  | Insert Coupon to be Added <u>or</u> Removed.                                                                                                                                                                                                    |              |                                                                                                  |                                                                                                  |
| <b>ADD Coupon</b>                   |                                                                                                                                                                                                                                                 |              |                                                                                                  |                                                                                                  |
| 3a.                                 | Coupon accepted and returned.                                                                                                                                                                                                                   | Coupon Teach | <br>(fast rate) | <br>(fast rate) |
| 4a.                                 | Automatically returns to Sales Mode. Coupon <u>addition</u> complete.                                                                                                                                                                           | Sales        | <br>(solid)     | <br>(cycle)     |
| <b>REMOVE Coupon</b>                |                                                                                                                                                                                                                                                 |              |                                                                                                  |                                                                                                  |
| 3b.                                 | Coupon disabled and returned.                                                                                                                                                                                                                   | Coupon Teach | <br>(fast rate) | <br>(fast rate) |
| 4b.                                 | Automatically returns to Sales Mode. Coupon <u>removal</u> complete.                                                                                                                                                                            | Sales        | <br>(solid)   | <br>(cycle)   |
| <b>Coupon <i>NOT</i> Recognized</b> |                                                                                                                                                                                                                                                 |              |                                                                                                  |                                                                                                  |
| 3c.                                 | Coupon returned. Inlet LEDs flash at original rate.                                                                                                                                                                                             | Coupon Teach | <br>(flash)   | <br>(flash)   |
| 4c.                                 | Insert another coupon (see Step 2 above)<br><b>OR</b><br> Hold button to return to Sales Mode (note unit returns automatically after 40 secs of inactivity). |              |                                                                                                  |                                                                                                  |

# Option / Dip Switch Settings

*Note: There are no switches on MDB only models.*

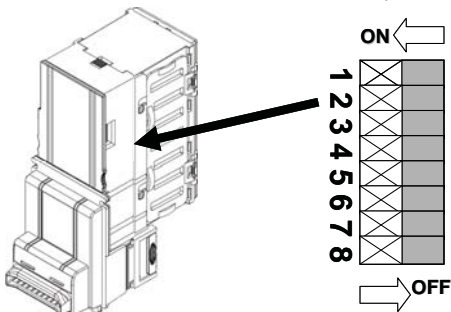

| Pulse Timing                  | Switch 1 | Switch 2 |
|-------------------------------|----------|----------|
| <b>50 / 50mS</b>              | ON       | ON       |
| <b>150 / 150mS</b>            | ON       | OFF      |
| <b>Custom</b>                 | OFF      | ON       |
| <b>Parallel (Credit Line)</b> | OFF      | OFF      |

|                       | ON              | OFF          |
|-----------------------|-----------------|--------------|
| <b>Switch 3</b>       | 4 Pulse / \$    | 1 Pulse / \$ |
| <b>Switch 4</b>       | Always Enabled  | Host Enabled |
| <b>Switch 5</b>       | Serial          | Pulse        |
| <b>Switches 6 - 8</b> | <i>Reserved</i> |              |

**Note:** "Custom" has a default setting of 200 / 200mS but can be reconfigured for a different timing. Please contact your Coinco Sales Rep for more information.



# Quick Release Bezel Operation

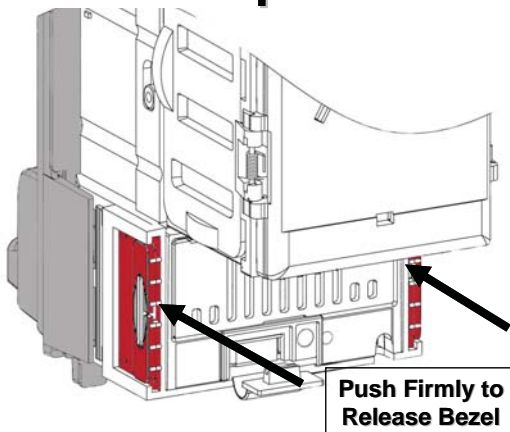

1. Push firmly on Quick Release Tabs using a screwdriver tip. Tabs will move towards bezel and latch.
2. Once both tabs are latched, the bill acceptor will separate from the bezel.
3. To reattach, push bill acceptor body firmly onto bezel until it locks.

# Smart Bezel™

## ***Communicates to Customer Which Bills Are Accepted***

Feature not available on all models.

***Denotes acceptance of both \$1 and \$5 bills.***

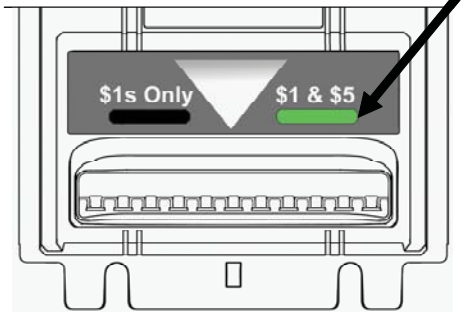

- ***\$1 & \$5 Is Lit When:*** Both bills accepted and change can be made for them.
- ***\$1s Only Is Lit When:*** Change can only be made for \$1 bills.

***Note:*** For correct operation, make sure \$1 and \$5 bills are enabled (see Configuration Settings).

*For more information on the Vantage™, please see the Operation and Service Manual, available at [www.coinco.com](http://www.coinco.com)*

Notes



---

**For technical support on this or any  
other Coinco product,  
contact your nearest Coinco Branch  
Office/Service Center.**

Coin Acceptors, Inc.  
U.S. World Headquarters  
300 Hunter Avenue  
St. Louis, MO 63124  
(314) 725-0100  
1-800-325-2646

Coin Acceptors, Inc.  
Canadian Headquarters  
1-435 Four Valley Drive  
Concord (Toronto), Ontario  
L4K 5X5 Canada  
Phone: (905) 738-5777  
1-800-387-9300

**email: [techsupport@coinco.com](mailto:techsupport@coinco.com)  
[www.coinco.com](http://www.coinco.com)**

Coinco Publication # 928997 Rev.2

05/2008

Printed in the U.S.A.