

4310104

Model 431

Shoppertron

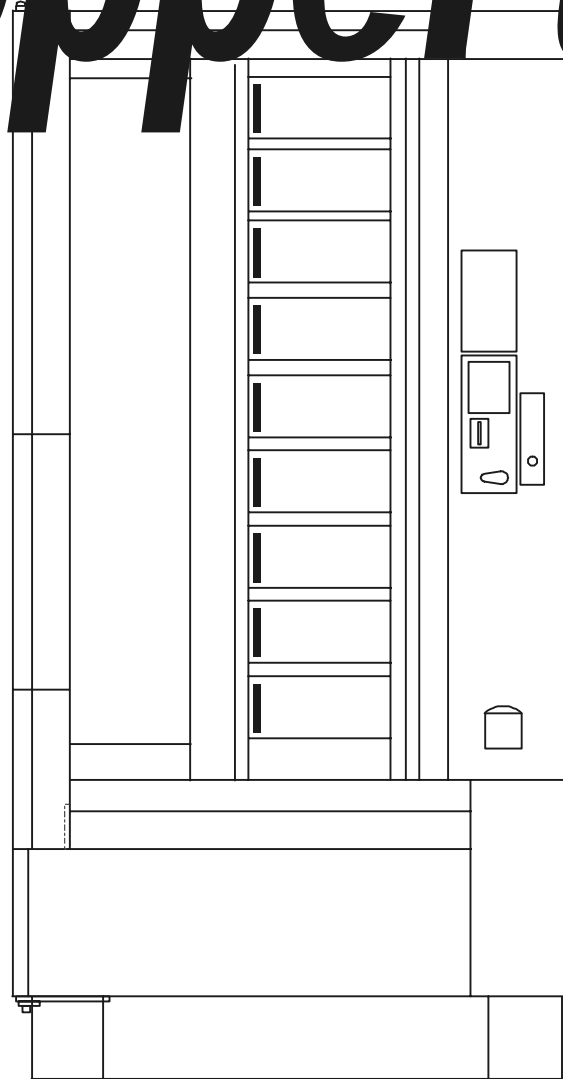

Troubleshooting & Repair Guide

CRANE MERCHANDISING SYSTEMS™ A Crane Co. Company
CMS PARTS & SUPPORT

12955 Enterprise Way
Bridgeton, Missouri 63044-1200
(314) 298-3500
www.CraneMS.com

Copyright © 7-01

4310104

Table of Contents

Section I. General Information.....	1
Differences Between Model 430 and 431.....	1
Preventing Circuit Damage From Electrostatic Discharge.....	2
Section II. Theory of Operation.....	3
1. Overall Merchandiser	3
A. Vend Door Operation.....	3
B. Double Pole Cold Door Switch	3
C. Loading Switch Operation.....	4
D. Refrigeration Triac.....	4
E. Refrigeration Control.....	4
F. Normal Drum Motor Operation.....	4
G. The Home Switch	5
H. The Service Keypad.....	5
I. The Power Circuit.....	5
J. The Coin Power Board	7
K. The Main Controller	7
Section III. Test Equipment.....	10
2. Using A Multimeter	10
A. General Information.....	10
B. Making Measurements.....	11
Section IV. Identifying Failures.....	13
Table 1. Possible Failures (Symptoms)	13
Table 2. Possible Failures (Diagnostic Messages)	30
Section V. Removal and Replacement Procedures.....	41
1. General Information.....	41
A. Duct and Blower Assembly	42
B. Interface PCB and Dumb Mech Power Supply PCB.....	43
C. Drive Motor Assembly	45
D. Power Panel Assembly	46
E. Stop Pin Solenoid Assembly.....	47
F. Refrigeration Unit	49
G. Refrigeration Compressor Components.....	50
H. Fluorescent Light Assembly	51
I. Vend Door.....	52
J. Drive Gear.....	54
K. Drive Shaft Bushing.....	54
L. Proximity Sensor (Home Switch)	55
M. Motion Sensor System.....	56
N. Controller PCB	57
O. Temperature Sensor	58
P. Triac/Drum Motor Capacitor.....	59
Q. Service Keypad.....	60

R. Direction Switch	61
S. Credit Display Assembly	62
T. Turret Assembly	63
U. Load Switch Assembly	65
V. Lock Bar Solenoid Assembly	66
W. Vend Door Switch	67
X. Monetary Door Switch.....	68
Y. Price Displays	69
Z. EPROM.....	70
Appendix A.Wiring Diagram	A-1

Alphabetical Index of Removal and Replacement Procedures

Controller PCB	57
Credit Display Assembly	62
Direction Switch	61
Drive Gear.....	54
Drive Motor Assembly	45
Drive Shaft Bushing.....	54
Duct and Blower Assembly	42
EPROM.....	70
Fluorescent Light Assembly	51
Interface PCB and Dumb Mech Power Supply PCB.....	43
Load Switch Assembly	65
Lock Bar Solenoid Assembly	66
Monetary Door Switch.....	68
Motion Sensor System	56
Power Panel Assembly	46
Price Displays	69
Proximity Sensor (Home Switch).....	55
Refrigeration Compressor Components.....	50
Refrigeration Unit	49
Service Keypad	60
Stop Pin Solenoid Assembly.....	47
Temperature Sensor	58
Triac/Drum Motor Capacitor	59
Turret Assembly	63
Vend Door Switch	67
Vend Door.....	52

Section I. General Information

Differences Between Model 430 and 431

If you are accustomed to working on a Model 430 Shoppertron, you need to be aware of some differences in the newer Model 431.

Electrical:

1. No separate power supply.
2. 30 V regulator for displays is on the interface PCB.
3. Main controller PCB power supply - J37 pins 1 & 2 are the 24 VAC input from the transformer. This 24 VAC is then rectified to 24 VDC which is then regulated to 5 VDC logic voltage.
4. Stop pin solenoid switch does not directly power the drum motor. Instead it switches 24 VDC to an opto-triac.
5. No motor direction PCB is present. That function is carried out on the interface PCB.
6. No separate refrigeration triac PCB. An off-board triac is controlled by the interface PCB.
7. No motion sensor PCB. An optical sensor mounted on the motor assembly sends a signal back to the interface PCB.
8. The coin mechanism power supply uses a 1 amp fuse. The 431 can either use a 110 VDC or 24 VDC coin mechanism with the same harness (15 pin Jones plug). A coin power supply is required with the 110 volt coin mechanism.
9. Separate connections on the controller PCB for serial, MDB, or pulse validators.
10. The loading switch is now located by the temperature sensor. It is also wired to the controller PCB. This renders it a less useful troubleshooting tool than on the 430.

Mechanical:

1. The refrigeration unit comes out as one complete unit.
2. The programming keypad is located on the display PCB cover.
3. The power panel is on the bottom right of the cabinet.

Model 431 Shoppertron Troubleshooting and Repair Guide

Preventing Circuit Damage From Electrostatic Discharge

Electronic printed circuit board assemblies are susceptible to physical damage, for example, broken components due to rough handling. In addition, printed circuit board assemblies (and their components, such as EPROMs) are subject to damage by various types of static electricity. Damage of this type is called **ELECTROSTATIC DISCHARGE (ESD)**. ESD can cause immediate damage to components on a circuit board assembly, or it can weaken them to the point where the damage will show up days, weeks, or months later.

PRECAUTIONS TO TAKE WHEN HANDLING PCB ASSEMBLIES

1. The PCB assembly is usually shipped in a cardboard shipping carton to prevent physical damage. Inside the carton, the PCB was placed in 1 of 3 types of closed protective bags: black translucent, smoked gray transparent, or pink transparent.
2. For storage, the best protection for the assembly is to leave it in its shipping carton. If it is removed from the carton, leave the assembly in its ***CLOSED storage bag while transporting, or until it is ready to be installed in a machine.***
3. Before handling the PCB assembly, be sure you are wearing a conductive wrist strap or other suitable ESD protective device. The conductive wrist strap should be connected to ground in the machine. This can be any ***PLATED exposed metal part. DO NOT CONNECT YOUR WRIST STRAP TO A PAINTED PART.***
4. Remove the new PCB assembly from its bag. Set the PCB assembly on top of the bag on a flat surface while you remove the old PCB assembly from the machine.
5. Pick up the new PCB assembly and set the old one down on the protective bag. Install the new PCB assembly in the machine.
6. Insert the old PCB assembly into the protective bag. Seal the bag.
7. If the old PCB assembly is to be returned, it is best to ship it in the same shipping carton you received with the new PCB assembly.

Section II. Theory of Operation

1. Overall Merchandiser

A. Vend Door Operation

1. Initial conditions: Credit has been inserted and the carousel is turned so the desired product is aligned with the vend door.
2. The vend door is opened to retrieve the product.
 - a. 30 VDC from the interface PCB is present at all door switches. As the door is moved, its switch is actuated, applying 30 VDC back to the interface PCB.
 - b. This voltage is changed to a logic level and routed to the controller PCB.
 - c. Circuitry on the controller PCB compares this logic level with other inputs verifying that the correct credit has been established, correct change is available on an overbuy, and the desired product is not sold out or otherwise unsuitable for vending.
 - d. The resulting output from this comparison is routed back to the interface PCB, placing a ground on J56 pin 13.
 - e. The vend door lock solenoid is energized, lifting the lock bar and allowing the vend door to be fully opened.
 - f. The movement of the lock bar actuating the lock bar switch allows the lock bar switch to move to its normally open contact, applying 30 VDC back to the controller card.
 - g. This voltage is changed to a logic level and routed to the controller PCB where it is used to inform the merchandiser that a vend has occurred and cancelling the credit and giving change if needed.

B. Double Pole Cold Door Switch

1. Opening the cold door actuates the cold door switch, and causes the following:
 - a. Power is removed from the compressor, the condenser fan motor, and the evaporator fan motor.
 - b. In the door closed position, 30 VDC is sitting at J59 pin 1 and routed to J59 pin 4 through the switch. This 30 VDC is removed from J59 pin 4 when the door is opened, informing the controller PCB that the door is open.
 - c. The controller records the time and date the door was opened, and the duration it was left open. (This data is viewable by pressing ). See the *Operators' Guide*.)
 - d. Resets the health control to either 30 or 45 minutes, depending on software version.

Model 431 Shoppertron Troubleshooting and Repair Guide

C. Loading Switch Operation

1. The loading switch is available for use when the cold door is open.
2. Actuate the loading switch:
 - a. The controller PCB sends a signal to the interface PCB to apply 120 VAC to J58 pin 4, which energizes the drum lock (stop) solenoid.
 - b. The drum lock solenoid pin moves away from the carousel, freeing it to move.
 - c. The drum lock solenoid also actuates the lock solenoid switch, applying 30 VCD from J59 pin 1 to J59 pin 5.
 - d. The resulting signal is sent to the controller PCB, which in turn instructs the interface PCB to energize the drum motor to turn right.
 - e. As the drum turns, motion sensor data is sent to the controller PCB, which causes the price displays to change appropriately with the products moving past the door.

D. Refrigeration Triac

1. The cold door is closed, and the temperature sensor reads a high cabinet temperature:
 - a. The controller PCB sends a signal to the interface PCB to turn the triac ON.
 - b. The triac sends 120 VAC to the compressor and the condenser fan.

E. Refrigeration Control

1. The controller PCB compares reference resistors with the resistance from the temperature sensor (located in the return airflow to the evaporator).
 - a. As air temperature rises, the return value to the controller PCB at J31 increases to a point where the compressor is required to run.
 - b. When that switch-on point is reached, the controller PCB latches the optical triac isolator (U8), located on the interface PCB. This turns on the refrigeration triac to run the compressor and the condenser fan motor.
 - c. When the compressor is running, the temperature drops, changing the resistance applied to the controller PCB by the temperature sensor. When the switch-off point is reached, the controller PCB switches off the optical triac isolator and thus turning off the compressor and condenser fan motor.

F. Normal Drum Motor Operation

1. An arrow key is pressed:
 - a. A signal is applied to the credit display PCB at J46.
 - b. The signal is routed from the credit display PCB at J45 to the controller PCB at J33.
 - c. The signal is finally routed from the controller PCB at J30 to the interface PCB at J55.
 - d. On the interface PCB, U7 is turned on, turning on Q3, resulting in a 120 VAC level on J58 pin 4.
 - e. The 120 VAC level is routed to the drum lock solenoid, energizing it and releasing the drum lock pin.
 - f. As the solenoid is energized, the drum lock switch closes, sending 30 VDC from J59 pin 1 to J59 pin 5, informing the controller PCB that the drum lock solenoid is energized.
 - g. The 24 VDC level is also applied to optical isolators on the interface PCB, routing 120 VAC to the appropriate side of the motor direction capacitor.

Model 431 Shoppertron Troubleshooting and Repair Guide

- h. The capacitor applies 120 VAC to either the clockwise or counterclockwise motor windings, causing the motor to rotate in the direction selected.
 - i. During drum rotation, the controller PCB is sent a signal from the motion sensor, verifying that the drum is rotating, and its position.
2. The arrow key is released:
 - a. The drum lock solenoid is de-energized, allowing the lock pin to contact the drum.
 - b. The 120 VAC is removed from the drum motor triac, de-energizing the motor.
 - c. The drum is driven until the lock pin engages the drum, causing it to stop.
 - d. The motion sensor detects the halt in movement, informing the controller PCB.

G. The Home Switch

1. The home switch is a magnetic reed type switch which is actuated by a magnet mounted on the drum on the left side of zone 1:
 - a. The home switch sends a signal to the controller PCB to establish a reference point.
 - b. The controller PCB counts pulses from the motion sensor wheel to determine the exact position of the drum after it is stopped by the solenoid stop pin.
 - c. The main controller now can:
 - Re-energize the drum solenoid to display any zone required,
 - Turn the drum to display a zone for a timed event,
 - Monitor all sales from each zone (tamper check is on), preventing further door openings at empty or contaminated compartments,
 - Face up and present the zone containing the most remaining products (prefer max set in the configuration menu).

H. The Service Keypad

1. Each of the sixteen buttons on the service keypad is supplied with a 60 Hz strobing dc signal (cannot be read with a meter). Each of the four column lines is supplied with a pulse at different times:
 - a. Column 1 is ON, all other columns are off.
 - b. Column 2 is ON, all other columns are off.
 - c. This continues through the last column, then repeats.
 - d. The main controller always knows which column is ON.
2. The four row lines are used for return signals to the main controller PCB.
3. Each row on the selection keypad monitors four switches.
4. A switch is pressed:
 - a. The strobing dc signal is sent to the main controller PCB on the row line associated with that switch.
 - b. The main controller PCB compares the row line with its knowledge of which column was being strobed to determine which switch was pressed.

I. The Power Circuit

1. The power circuit consists of the following components:
 - a. Power cord

Model 431 Shoppertron Troubleshooting and Repair Guide

The merchandiser is supplied with a service cord for the country of use and is terminated in a grounding type plug. The wall receptacle used for this merchandiser must be properly polarized, grounded, and of the correct voltage. Refer to your *Operators' Manual* to determine these parameters. Operating the merchandiser from a source of low voltage will **VOID THE WARRANTY**. Each merchandiser should have its own electrical circuit and that circuit should be protected with a circuit breaker or fuse conforming to local regulations.

b. Main switch

The main switch is a single pole, double throw switch rated at 20 amps, 125-250 volts ac. When the switch is closed (ON position), voltage is transferred to the EMI filter and throughout the rest of the merchandiser.

c. Main circuit breaker

The main circuit breaker is rated at 20 amps, 250 volts ac and is placed in line just after the main switch. The main breaker is designed to protect the merchandiser from overcurrent conditions in the electrical circuitry of the location. These conditions could cause erratic operation of the merchandiser, damage internal components, or cause electrical shock and personal injury.

CAUTION

The overcurrent protection provided by the main circuit breaker must never be compromised. Shorting or jumping across this breaker WILL compromise this protection and could cause severe problems.

d. EMI filter

The EMI filter (also known as the line load filter) is rated at 5 amps, 115/250 volts ac, 50/60 Hz. The internal components consist of two 850 μ H (micro Henry) inductors, a 0.01 μ F (micro Farad) capacitor, and two 2800 pF (pico Farad) capacitors. The filter removes "noise" that may be riding on the ac voltage. This unstable, tagalong voltage riding the ac line could adversely affect and cause erratic operation of the electronic components inside the merchandiser (i.e. interface PCB, controller PCB, etc.). Failure of any part of this filter could result in improper power distribution within the merchandiser, resulting in (but not limited to) fluorescent lamp failure, improper PCB operation, or tripping the main circuit breaker.

e. Transformer

The double primary winding, 120 volt ac stepdown transformer provides 24 volts ac to the controller PCB for distribution to other low voltage components within the merchandiser. The voltage is further filtered, rectified, and dropped to supply various circuits.

Model 431 Shoppertron Troubleshooting and Repair Guide

f. Electronic breaker

This 3 amp circuit breaker is designed to provide protection from overcurrent conditions that may potentially damage low voltage components such as circuit boards, which are particularly vulnerable to high current.

CAUTION

The overcurrent protection provided by the electronic circuit breaker must never be compromised. Shorting or jumping across this breaker **WILL** compromise this protection and could cause severe problems.

g. Interlock switch

The interlock switch consists of two single-pole double-throw switches rated at 10 amps, 125/250 volts. Each of the two switches serves a distinct purpose. Internal switch one has connections at Comm 1 (common terminal) and O1 (normally open terminal). 120 volts ac is present at Comm 1, which is switched to O1 when the door is closed. This voltage is then sent through connector J127 pin 2 to the power evaporator fan. Internal switch two has connections at Comm 2 and O2. Comm 2 is connected through J92 pin 3 to the interface PCB at J59 pin 4. O2 is connected through J92 pin 4 to the interface PCB at J59 pin 1. 30 volts dc is present at interface PCB J59 pin 1. When the door is closed, this 30 volts dc is routed through the interlock switch back to the interface PCB connector J59 pin 4. This voltage is a reference to determine when the door is closed to reset the health control.

J. The Coin Power Board

1. The coin power board is part of the power circuit and also part of the monetary circuit. Its purpose is to provide dc voltage to the coin mechanism.
 - a. The coin power board has a full wave rectifier (diodes D1 - D4) that converts 120 volts ac from the output of the EMI filter into 120 volts dc for the coin mechanism.

CAUTION

Low input voltage to the coin power board will result in a low output voltage. This could cause erratic operation of the coin mechanism such as jackpotting, and could even cause damage to the controller PCB.

- b. The coin power board contains a 0.1 μ F capacitor which functions as a noise filter for the incoming ac voltage prior to rectification.
- c. In line with the incoming ac voltage is a 5-watt ceramic wire-wound resistor in combination with a 1 AGC fuse. In an overcurrent situation, the resistor develops current which allows the fuse to blow and protect the bridge rectifier from damage.
- d. A variable resistor on the rectifier output filters noise from the dc voltage. This is necessary to provide the cleanest possible voltage for proper coin mechanism operation.

K. The Main Controller

1. The main controller PCB processes all information and data for the entire merchandiser, and carries out its decision making functions. The main controller PCB is connected (directly or indirectly) to every major component within the merchandiser. It receives and processes a variety of inputs, resulting in several outputs and functions. The microproces-

Model 431 Shoppertron Troubleshooting and Repair Guide

sor (U1) works in conjunction with other circuitry on the controller PCB to monitor conditions from peripheral devices. Based on input from those devices, diagnostic messages are issued (see **Possible Failures (Diagnostic Messages)** on page 30).

2. All timer settings, data processing results (sales and vend data, etc.), and machine configuration settings are stored in Random Access Memory (RAM) U3, also known as the Dallas chip.
3. Erasable Programmable Read-Only Memory (EPROM) U2 is known as the “personality” chip. It contains all the instructions that make your merchandiser what it is (snack machine, coffee, etc.). This device is identified with a software version number label. Refer to this label when ordering a new EPROM.
4. Two onboard light emitting diodes (LED) display the merchandiser’s condition. A lighted LED 1 indicates power is applied to the controller PCB; a flashing LED 2 indicates the controller PCB is active and the EPROM is operating.
5. The function of the main controller PCB connectors is as follows:
 - a. J30 handles all data transfer between the main controller PCB and the interface PCB, via a 16 conductor ribbon cable.

CAUTION

Disruption of this data stream will result in a *COMM LINK* error (see **Possible Failures (Diagnostic Messages)** on page 30). This condition will put the merchandiser out of service, displaying the *TEMPORARY OUT OF SERVICE* message.

Pins 2 through 14 provide these communication via U7 and U1. Pins 1 and 15 supply 5 volts dc for the operation of logic circuits.

- b. J33 is the connection to the display PCB, supplying it with low dc voltage for beeper and display operation. The data which is displayed reflects the state of the merchandiser, command control, and diagnostics. All display data is controlled through U13A, U6, and U9C.
- c. J35 is the DEX port.
- d. J36 is the printer port. Pin 1 is a ground reference for data transmission (pin 2), receive (pin 3), and return transmission signal (pin 4). Data transfer is controlled by U14. Pins 1 and 4 provide 5 volts dc or logic circuit operation.
- e. J37 receives 24 volts ac from the transformer (see **The Power Circuit** on page 5) on pins 1 and 2. This voltage is rectified (bridge rectifier BR1), regulated (regulator REG 1), filtered, and dropped to 5 volts dc for use as high and low (on/off) signals for all the logic circuits on the controller PCB, as well as other onboard uses. The unregulated 24 volts dc is also used by various devices on the controller PCB.
- f. J38 pins 1 and 2 supplies unregulated 24 volts dc power to the interface PCB, where it is regulated for onboard use.
- g. J39 is the Multi Drop Bus (MDB) port. Unregulated 24 volts dc power is supplied on pins 5 and 6, used to power all the MDB protocol capable monetary units (coin mechanism, bill validator, card reader, etc.). Pins 1 and 2 provide regulated and filtered 5 volts dc to power monetary unit logic circuits. Master data transmission is accomplished at pin 3; data reception is accomplished at pin 4.

Model 431 Shoppertron Troubleshooting and Repair Guide

- h. J40 is the dumb coin mechanism port. Unregulated 24 volts dc is supplied via pins 11 and 12 to 24-volt coin mechanisms. Pin 6 is a reset line used to inform the controller PCB of the presence of the dumb coin mechanism. This reset pulse only occurs once on power up and is not used again unless a coin mechanism is changed from dumb to MDB and back to dumb again. Lows at pins 1, 2, and 3 initiate payout signals to the coin mechanism to pay out nickles, dimes, and quarters. These lows are controlled by U6. A low at pin 4 enables the coin acceptance circuit identifying the coin inserted into the mechanism. The data from the mechanism is sent through U12 and U13B to U1 for evaluation. Data transmission is handled by pin 5 (interrupt, low for data present), 7 (data received), and 8 (send data). Pins 9 and 10 supply regulated and filtered 5 volts dc for coin mechanism logic circuit operation.
- i. J41 is the serial validator port. Communications protocol here is similar to that taking place at J40. A low at pin 2 enables the bill acceptance circuit which identifies the received bill. The data from the validator is sent through U12 and U13B to U1 for evaluation. Data transmission is handled by pin 5 (interrupt, low for data present), 6 (data received), and 5 (send data). Pins 1 and 7 supply regulated and filtered 5 volts dc for bill validator logic circuit operation.
- j. J42 is the pulse validator port, used with 110 volt coin systems only. Serial data communication is a constant stream of information traveling in both directions (send and receive). Pulse operation is based on a single signal being sent and processed at the microprocessor for response. No data is transferred, so “smart” responses are not possible. Each bill accepted generates a pulse which is acknowledged and processed by the microprocessor. Only a one dollar bill can be accepted, because the device can’t tell the difference between denominations. Pins 1 and 2 provide 115 volts ac connected through optical isolator U11, preventing high voltage from interacting with low voltage board components.

Section III. Test Equipment

2. Using A Multimeter

A. General Information

WARNING

Some test points you will be measuring carry high voltages. Take care to avoid contact with those points to avoid personal injury or death.

CAUTION

Make sure your multimeter is set to the correct function for the measurement you are taking, otherwise damage to the multimeter could result.

Read and familiarize yourself with the multimeter's instructions prior to using it for the first time.

- Turn on the meter if it is not already on.
- Turn the selector to change between the meter's functions and familiarize yourself with the displays.

CAUTION

Some voltage ranges might show a phantom reading in the display when the test leads are not connected to a circuit. This is normal. When you connect the test leads to a circuit, a real measurement appears.

Measuring High-Voltages

When you use the meter to check a high-voltage circuit, do not try to position both test leads at once. Instead, use an insulated slip-on alligator clip to attach one of the test leads to the neutral or ground lead of the circuit (a bare, green, or white lead), or a piece of bare metal that is attached to the chassis of the machine. Then check for high voltage using the remaining probe. This helps prevent your accidentally touching a hot wire, because you only need to concentrate on one test lead at a time.

Using Display Hold (not on all meters)

Your meter's display hold feature lets you hold the current reading on the meter's display. The meter holds the measured value on the display even if you remove the test leads from the circuit.

Using Range Hold

Your meter is preset to automatically set a constant measurement range for voltage or resistance you measure. The range hold feature lets you hold the current measurement range.

Model 431 Shoppertron Troubleshooting and Repair Guide

B. Making Measurements

Measuring DC/AC Voltage

Consult your multimeter's instructions to determine the maximum safe DC voltage you are allowed to measure.

1. Turn on the meter if it is not already on.
2. Turn the selector to the proper setting to measure DC or AC voltage.
3. Touch the test leads to the circuit you want to test.

CAUTION

Depending on your meter, measuring AC voltages may cause "AC" to appear on the left side of the display and "V" or "mV" appear on the right side. Measuring DC voltages may cause "v" or "mv" only to appear on the right side of the display. A thick black bar may appear on the left side of the display if the polarity of the voltage you are testing is negative.

Measuring Resistance

The resistance measuring circuit in your meter compares the voltage gained through a known resistance (internal) with the voltage developed across an unknown resistance.

4. Remove all power from the circuit under test and discharge all capacitors.
5. Turn the selector to Ohms (Ω).

Familiarize yourself with the display by touching the test leads together (short circuit). The display should show "0". Separate the leads to simulate an open circuit. The display may show ∞ (infinite), flash a high reading, or other. The instructions for your meter should tell you what to look for.

CAUTION

Never connect the test leads to a source of voltage while the selector is set to Ohms (Ω). Otherwise, damage to your multimeter could result.

6. Touch the test leads across the circuit you want to measure, or remove one of the leads of the component you want to measure from its circuit and touch the test leads across the component. The resistance value appears.

If you are measuring resistance of about 1 MOhm or more, the display might take a few seconds to stabilize. This is normal.

As with the voltage range, use the measuring units that appear on the display to determine the current resistance range. If only Ω appears, the values of the measurements are in Ohms. If K and Ω appear, the meter is measuring kilOhms (1 kilOhm = 1000 Ohms). If M and Ω appear, the meter is measuring MegOhms (1 MegOhm = 1,000,000 Ohms).

Model 431 Shoppertron Troubleshooting and Repair Guide

Checking Continuity

You can use the multimeter to check for shorted or open electrical circuits.

1. Remove all power from the circuit under test and discharge all capacitors.
2. Set the selector to Ohms (Ω).
3. Touch the test leads across the circuit you want to measure. Depending on your multimeter, a buzzer sounds if the circuit resistance is less than about 50 Ohms (meaning the circuit is continuous or shorted). Otherwise look for a low resistance reading on the display.
4. Touch the test leads across the circuit you want to measure. Depending on your multimeter, a buzzer sounds if the circuit resistance is less than about 50 Ohms (meaning the circuit is continuous or shorted). Otherwise look for a low resistance reading on the display.

Section IV. Identifying Failures

This section contains two tables of possible failures. When your merchandiser does not work properly, you will either know which part is failing, or you will see a diagnostic message in the display, or both. In the tables, first find the appropriate failure or diagnostic message. To the right, there is a list of one or more possible causes of the problem; with each possible cause having one or more remedies. Perform the maintenance tasks in the order suggested, referring to the repair procedure, wiring diagrams, or other resource as directed.

Table 1 Possible Failures (Symptoms)

Symptom	Possible Failure(s)	Do This:	Refer To:
Carousel turns back and forth.	Stop pin solenoid out of adjustment.	1. Adjust stop pin.	Stop Pin Solenoid Assembly on page 47
	Loose, dirty, or damaged motion sensor wheel.	2. Inspect wheel. Clean, tighten, or replace as necessary.	Motion Sensor System on page 56
	Bad motion sensor.	3. Replace motion sensor.	
	Broken or cracked motor coupling or pins.	4. Inspect motor coupling and pins; replace as necessary.	Drive Shaft Bushing on page 54
	Bad interface PCB.	5. Replace interface PCB.	Interface PCB and Dumb Mech Power Supply PCB on page 43

Model 431 Shoppertron Troubleshooting and Repair Guide

Table 1 Possible Failures (Symptoms) - Continued

Symptom	Possible Failure(s)	Do This:	Refer To:
Carousel rotates continuously; can't home.	Defective proximity sensor (home switch).	1. Check operation of the proximity sensor with a magnet and an ohmmeter. a. Replace proximity sensor.	Proximity Sensor (Home Switch) on page 55
	Dirty or damaged motion sensor wheel.	2. Inspect wheel. Clean or replace as necessary.	Proximity Sensor (Home Switch) on page 55
	Stuck direction key.	3. Check direction switch; replace if necessary.	Direction Switch on page 61
	Stop pin solenoid is malfunctioning.	4. Check stop pin solenoid for proper operation; replace if necessary.	Stop Pin Solenoid Assembly on page 47
	Defective motion sensor.	5. Replace motion sensor.	Motion Sensor System on page 56
	Defective interface PCB.	6. Replace interface PCB.	Interface PCB and Dumb Mech Power Supply PCB on page 43

Model 431 Shoppertron Troubleshooting and Repair Guide

Table 1 Possible Failures (Symptoms) - Continued

Symptom	Possible Failure(s)	Do This:	Refer To:
Frozen products, or refrigeration unit running all the time	Defective temperature sensor.	1. Replace temperature sensor.	Temperature Sensor on page 58
	Defective triac.	2. Replace the triac.	Triac/Drum Motor Capacitor on page 59
	Defective interface PCB.	3. Replace interface PCB.	Interface PCB and Dumb Mech Power Supply PCB on page 43
	Defective controller PCB.	4. Replace controller PCB.	Controller PCB on page 57
Frozen evaporator/health control error.	Defective temperature sensor.	1. Replace temperature sensor.	Temperature Sensor on page 58
	Defective triac.	2. Replace triac.	Triac/Drum Motor Capacitor on page 59
	Air is leaking through gaskets.	3. Check gaskets; replace as necessary.	
	Defective interface PCB.	4. Replace interface PCB.	Interface PCB and Dumb Mech Power Supply PCB on page 43
	Low refrigeration charge.	5. Check charge; recharge as necessary.	

Model 431 Shoppertron Troubleshooting and Repair Guide

Table 1 Possible Failures (Symptoms) - Continued

Symptom	Possible Failure(s)	Do This:	Refer To:
Compressor will not operate.	Improper power source.	1. Make sure machine is plugged in to a live outlet with proper voltage/frequency and circuit size. Correct as required.	
	Bad interlock switch.	2. Check operation of the interlock switch. Press the switch or open and close the door. Proper operation of the switch will cause machine to go to a health control countdown. Replace the interlock switch.	Power Panel Assembly on page 46
	Bad temperature sensor or harness.	3. View temperature and sensor diagnostics. If problem appears to be intermittent, jiggle sensor wires to find bad connection. a. Replace harnesses. b. Replace temperature sensor.	<i>Operators' Guide</i>
			Temperature Sensor on page 58
			Temperature Sensor on page 58
Bad compressor or components.	4. With the machine empty, open the door and allow the sensor temperature to rise well above 45 F. Reset health safety and close doors. Look for a decimal point on temperature display, which indicates power is on for compressor. Replace components as required.		
		5. Check compressor starting circuit for short or failed overload device.	Refrigeration Compressor Components on page 50

Model 431 Shoppertron Troubleshooting and Repair Guide

Table 1 Possible Failures (Symptoms) - Continued

Symptom	Possible Failure(s)	Do This:	Refer To:
Compressor operates, but unit will not cool.	Improper airflow through refrigeration assembly, resulting in frozen evaporator conditions as shown (figure 1).	<ol style="list-style-type: none"> 1. Check for obstructions on the condensing unit inlet and outlet grilles/screens. Check the condensing coil for fouling, dirt, grime, etc. on the fins. Clean grilles, screens, and coil as required. 2. Check for low charge, bad seals around the door, or a bad refrigeration unit seal. 3. The back of the machine should be no closer than 6 inches to any walls or obstructions and underside of machine should be clear. Move machine to provide adequate room for airflow in and out of machine as required. 	



Figure 1. Two views of the frozen refrigeration unit.

Compressor operates, but unit will not cool (Continued).	Improper operation of evaporator drain.	<ol style="list-style-type: none"> 1. Check for proper positioning of the evaporator drain pan trap. The trap must be operational to prevent hot, moist air from being drawn into the evaporator. If trap is the old elbow type fitting, replace with the new "S" type trap NV part number 4314065. Reposition trap or replace as necessary. 	Refrigeration Unit on page 49
--	---	---	--------------------------------------

Model 431 Shoppertron Troubleshooting and Repair Guide

Table 1 Possible Failures (Symptoms) - Continued

Symptom	Possible Failure(s)	Do This:	Refer To:
Compressor operates, but unit will not cool (Continued).	Air leaks.	<ol style="list-style-type: none"> 1. Check all drain tube, refrigerant tubing, and wiring penetrations into the evaporator box for adequate sealing. <ol style="list-style-type: none"> a. Replace or reposition perma-gum material to create an air-tight seal. b. Caulk areas and the sheet metal box and the gasket near the corners of the evaporator inlet seal. (Both the sheet metal box and the gasket can have leakage in these corner areas.) Seal these areas well with a high quality silicone caulk product. c. Caulk the air seal between the return air duct and bottom cabinet shelf in the back left corner of the cabinet. This will require removal of the turret and left false wall. The foam rope gasket should be in place between the duct and the shelf. Caulk this entire seal area liberally with a high quality, clear silicone caulk product. d. Caulk the gasket seal area on the inside of the window glass. This will require removal of the clear lexan cover on the glass. Caulk the area where the gasket seals to the door opening liberally, with a high quality clear silicone caulk product. 	<p>Turret Assembly on page 63</p>

Model 431 Shoppertron Troubleshooting and Repair Guide

Table 1 Possible Failures (Symptoms) - Continued

Symptom	Possible Failure(s)	Do This:	Refer To:
Compressor operates, but unit will not cool (Continued).	Misaligned door or bad seal. (Look for condensation around the door or ice build-up on the evaporator (figure 1).)	1. Check the main door for alignment and sealing to the cabinet. Realign door and/or adjust door latch as required. To check door seal, insert a dollar bill between an open door and cabinet and hold there while door is closed and latched. A good seal will not allow you to pull the dollar bill out. Check at 3 places on door sides, top, and bottom. If seal with cabinet is still poor, order a new door gasket kit and install. Use NV part #4311195 for a door with white liner, and NV part #4311196 for a door with black liner.	

Model 431 Shoppertron Troubleshooting and Repair Guide

Table 1 Possible Failures (Symptoms) - Continued

Symptom	Possible Failure(s)	Do This:	Refer To:
Compressor operates, but unit will not cool. (Continued)	Dirty condenser, bad evaporator fan, or harness.	<ol style="list-style-type: none"> 1. Check to see that the evaporator fan is providing air to the turret (air is coming out of the air holes). 2. Remove the refrigeration unit and check to see that the fan is mounted to the lid of the evaporator box. <ol style="list-style-type: none"> a. Repair wiring as required and repair fan mounting as required. 3. Check routing of the evaporator fan harness. The harness should not be routed across any gaskets. <ol style="list-style-type: none"> a. Re-route harness through wall of evaporator box as required. 4. Check the evaporator for ice build-up (figure 1). 5. Check that the evaporator is properly attached and positioned above the condensate pan and that the condensate pan is not retaining water. <ol style="list-style-type: none"> a. Reattach evaporator if required. b. Adjust condensate pan drain tube as required to insure drainage with trap still operational. 	Refrigeration Unit on page 49
	Low refrigerant charge.	<ol style="list-style-type: none"> 1. Check the refrigeration unit for a low charge and/or low capacity. <ol style="list-style-type: none"> a. With the refrigeration unit removed, unplug the evaporator fan harness, and run the compressor and condensing fan with the unit at ambient conditions. A unit with proper refrigerant charge and capacity, will cause ice build-up on the evaporator from front to back and frosting on the suction line clear back to the compressor, in less than 10 minutes (figure 1). If this does not occur, the unit's charge and/or capacity is suspect, and the unit should be replaced. 	

Model 431 Shoppertron Troubleshooting and Repair Guide

Table 1 Possible Failures (Symptoms) - Continued

Symptom	Possible Failure(s)	Do This:	Refer To:
No display		Are both lights on the main controller operating?	
		If Yes...	
		1. Check that the EPROM is installed correctly in the socket.	EPROM on page 70
		2. Disconnect the vertical price display and see if the other display lights.	Price Displays on page 69
		a. If so, replace the vertical price display.	
		3. Check for 30 vdc across J57 pin 1 and 2.	Price Displays on page 69
		a. If present, replace the display.	Interface PCB and Dumb Mech Power Supply PCB on page 43
		b. If not present, replace the interface PCB.	
	If No...		
1. Check connectors on main controller for good contact.	Controller PCB on page 57		
2. Check the electronics breaker.	Power Panel Assembly on page 46		
3. Check for 5 vdc between J33 pin 1 and pin 6.			
4. If not present, replace the main controller.	Controller PCB on page 57		

Model 431 Shoppertron Troubleshooting and Repair Guide

Table 1 Possible Failures (Symptoms) - Continued

Symptom	Possible Failure(s)	Do This:	Refer To:
Credit display lights but, price displays do not.	Loose contacts.	1. Check connector J34 on the main controller for good contact.	
		2. Check the connector on the bottom of the price display for good contact.	
	Incorrect voltages.	3. Check for 30 vdc at the J1 connector between pin 10 and pin 11. a. If not present, replace the interface PCB.	Interface PCB and Dumb Mech Power Supply PCB on page 43
		4. Check for 5 vdc at J1 connector between pin 11 and pin 7. a. If 5 vdc is not present, replace the main controller. b. If 5vdc is present, replace the price display.	Controller PCB on page 57 Price Displays on page 69
Not all vertical displays illuminate.	Bad display board.	1. Replace suspected bad display with one that is known good.	Price Displays on page 69
		2. Does the display work properly? a. If so, replace the removed display. b. If not, use an ohmmeter to check the continuity of the affected lead in the ribbon cable.	Price Displays on page 69
		3. Does the ribbon cable check good? a. If so, replace the main controller. b. If not, replace the ribbon cable.	Controller PCB on page 57

Model 431 Shoppertron Troubleshooting and Repair Guide

Table 1 Possible Failures (Symptoms) - Continued

Symptom	Possible Failure(s)	Do This:	Refer To:
Door display flashing open.		1. Check the vend door switch for proper adjustment.	Vend Door Switch on page 67
		2. Check for pinched wires under the lockbar assembly.	
		3. Check J56 on the interface PCB for good contact.	
		4. Replace the harness from J56 to the switches.	
		5. Replace the interface PCB	Interface PCB and Dumb Mech Power Supply PCB on page 43
		6. Check or replace ribbon cable from J55.	
		7. Replace the controller PCB.	Controller PCB on page 57
Two doors flash open when only one is selected		1. Check for crossed wires on the vend door switches.	
		2. Check solenoid lock switch and J56 on the interface PCB.	
		3. Replace the interface PCB.	Interface PCB and Dumb Mech Power Supply PCB on page 43

Model 431 Shoppertron Troubleshooting and Repair Guide

Table 1 Possible Failures (Symptoms) - Continued

Symptom	Possible Failure(s)	Do This:	Refer To:
Service keypad completely dead.		1. Check monetary door switch for proper operation.	
		2. Replace the service keypad.	Service Keypad on page 60
		3. Check connector J33 on main controller for good connection.	
		4. Replace the main controller.	Controller PCB on page 57
Some keys do not function on the service keypad.		1. Replace the service keypad.	Service Keypad on page 60
		2. Replace the credit display.	Credit Display Assembly on page 62
		3. Check the harness between J33 and J45; replace if necessary.	
		4. Check the monetary door switch for proper operation.	Monetary Door Switch on page 68
		5. Replace the main controller.	Controller PCB on page 57
Vend door solenoid fires continuously, no doors flashing open.		1. Disconnect J55 from the interface PCB. Does the solenoid continue to fire? a. If so, replace the interface PCB. b. If not, replace the ribbon cable.	Interface PCB and Dumb Mech Power Supply PCB on page 43
		2. Replace the main controller.	Controller PCB on page 57

Model 431 Shoppertron Troubleshooting and Repair Guide

Table 1 Possible Failures (Symptoms) - Continued

Symptom	Possible Failure(s)	Do This:	Refer To:
Prices change on lower section of drum, will take odd cents.	Bad price display	1. Check to see if discounts are set.	<i>Operators' Guide</i>
		2. Check price display board.	
		3. Install a new price display board.	Price Displays on page 69
Will not accept coins; display shows <i>COINS ONLY</i> .		1. Check configuration.	<i>Operators' Guide</i>
		2. Try to pay out coins. <ul style="list-style-type: none"> a. If coins will pay out, replace coin mechanism or controller PCB. b. If coins do not pay out, check power to coin mechanism. See <i>NO MECH</i> diagnostic message. 	Controller PCB on page 57
			<i>NO MECH</i> on page 35
		3. Check and refer to diagnostic message.	<i>Operators' Guide</i>
		4. Check 1 amp coin mechanism fuse.	
Will not payout all denomination of coins		1. Check configuration.	<i>Operators' Guide</i>
		2. Replace the coin mechanism.	
		3. Replace the coin mechanism harness.	
		4. Replace the main controller.	Controller PCB on page 57

Model 431 Shoppertron Troubleshooting and Repair Guide

Table 1 Possible Failures (Symptoms) - Continued

Symptom	Possible Failure(s)	Do This:	Refer To:
Will not accept dollar bills, validator does not attempt to accept:	Possible machine configuration problem. NOTE: Bill validator will not accept bills if display shows <i>USE EXACT CHANGE</i> .	1. Check validator setup, and coin mechanism setup. Ensure <i>NO VALIDTR</i> is not selected.	<i>Operators' Guide</i>
		2. Does validator cycle on power up? a. If not, check for a diagnostic message. b. If so, check harness connection between validator and controller PCB.	
		3. Check that the validator switches are in the correct positions.	<i>Bill Validator Operators' Manual</i>
		4. Set the validator switches in the correct positions.	
		5. Check for 110 VAC at the red and yellow power wires at the bill validator. a. If power is not present, replace the validator harness. b. If power is present, replace the bill validator.	
		6. Replace the main controller.	Controller PCB on page 57
Unit will not accept bills; keeps returning them.		1. Possible old currency, try another bill.	
		2. Replace the validator.	
		3. Set security switches to standard.	<i>Bill Validator Operators' Manual</i>
Unit does not give credit for dollar bills.		1. Try another validator.	
		2. Check switch settings.	
		3. Replace the validator harness	
		4. Replace the main controller	Controller PCB on page 57

Model 431 Shoppertron Troubleshooting and Repair Guide

Table 1 Possible Failures (Symptoms) - Continued

Symptom	Possible Failure(s)	Do This:	Refer To:
Compressor will not run.		1. Check temperature reading on display.	<i>Operators' Guide</i>
		a. If below 37°, compressor should not run.	Temperature Sensor on page 58
		b. If 0°, check connection on temperature sensor and at main controller connector J31. If connections are good, replace temperature sensor.	Refrigeration Unit on page 49
		c. If above 41° (or 45°, depending on software version), and the condenser fan is running, check the following: <ul style="list-style-type: none"> • Start capacitor • Start relay • Thermal overload 	
		d. If all of the above check good, replace the compressor.	

Model 431 Shoppertron Troubleshooting and Repair Guide

Table 1 Possible Failures (Symptoms) - Continued

Symptom	Possible Failure(s)	Do This:	Refer To:
Compressor will not run (continued).		<p>e. If above 45° (or 45°, depending on software version), and neither the compressor nor the condenser fan is running, check:</p> <ul style="list-style-type: none"> • Compressor connector is plugged in, • Door switch is wired properly and making good contact, • Interface PCB connector J58 is connected properly, • Ribbon cable from controller PCB connector J30 to interface PCB J55. <p>If all connections are good,</p> <ol style="list-style-type: none"> 1. Replace the triac. 2. Replace the interface PCB. 3. Replace the controller PCB. 	<p>Triac/Drum Motor Capacitor on page 59</p> <p>Interface PCB and Dumb Mech Power Supply PCB on page 43</p> <p>Controller PCB on page 57</p>

Model 431 Shoppertron Troubleshooting and Repair Guide

Table 1 Possible Failures (Symptoms) - Continued

Symptom	Possible Failure(s)	Do This:	Refer To:
Compressor fails to cycle on and off.		1. Compare machine's temperature readout with a known good thermometer placed inside the cabinet. <ol style="list-style-type: none"> a. If temperature display reading disagrees with thermometer, replace the temperature sensor. 	Temperature Sensor on page 58
		2. Unplug the ribbon cable from J55 of the interface PCB. If the compressor stops: <ol style="list-style-type: none"> a. Replace the ribbon cable. b. Replace the controller PCB. 	
			Controller PCB on page 57
Compressor runs constantly with door open.		1. If the compressor continues running, after unplugging J55, plug J55 back in and unplug J58 from the interface PCB.	Interface PCB and Dumb Mech Power Supply PCB on page 43
		2. If the compressor stops, replace the interface PCB.	
		3. If the compressor continues to run after unplugging J58, plug J58 back in.	
		4. Unplug the connector at the triac. <ol style="list-style-type: none"> a. If the compressor stops, replace the triac. 	Triac/Drum Motor Capacitor on page 59



Model 431 Shoppertron Troubleshooting and Repair Guide

Table 2 Possible Failures (Diagnostic Messages)

Diagnostic Message	Failure	Do This:	Refer To:
<i>BILL DATA</i>	The main controller does not recognize the bill validator.	1. Check to see if the correct validator is configured.	<i>Operators' Guide</i>
		2. Check the switches on the validator.	
		3. Check to be sure the connectors on the main controller and validator are making good contact.	
		4. Replace the validator harness.	
		5. Replace the validator.	
<i>CANT HOME</i>	No drum home position is detected when the magnet in the center of zone 1 left passes over the home switch.	Repeat the <i>SOLENOID</i> test.	<i>SOLENOID</i> on page 37
		1. Is the magnet physically present? If not, install a new magnet.	
		2. When the magnet passes over the home switch, the motor will pause, then present a zone.	
		3. If no pause occurs, measure the home switch voltage input to the interface PCB at J59 pin 3: a. Normally at 0 vdc, b. When the magnet operates the switch, pin 3 pulses to +30vdc.	
		4. Check proximity switch connector J107.	

Model 431 Shoppertron Troubleshooting and Repair Guide

Table 2 Possible Failures (Diagnostic Messages) - Continued

Diagnostic Message	Failure	Do This:	Refer To:
<i>CANT HOME</i> (Continued)		5. Check proper operation of home switch: a. Turn machine OFF. b. Manually engage the solenoid so you can rotate the drum by hand. c. Disconnect J107 and put the ohmmeter leads across both pins on the switch leads. d. Rotate drum so the magnet passes over the home switch. e. If meter shows greater than 2Ω, replace the home switch.	Proximity Sensor (Home Switch) on page 55
		6. Check wiring harness; replace as necessary.	
		7. Replace the interface PCB.	Interface PCB and Dumb Mech Power Supply PCB on page 43
<i>CHK DBV</i>	The validator is jammed.	1. Check validator for a bill jam.	
<i>CHK DBV</i>		2. Open and close the stacker.	
<i>CHK DBV</i>		3. Check validators switch settings.	
<i>CHK DBV</i>		4. Replace the validator.	
<i>CHK PRICE</i>	Price error detected and changed to maximum.	1. Press  and check that prices are set.	
<i>CHK CONFIG</i>	A product configuration value is out of bounds and set to nominal.	1. Press  and check ALL the details carefully. Reset as necessary.	

Model 431 Shoppertron Troubleshooting and Repair Guide

Table 2 Possible Failures (Diagnostic Messages) - Continued

Diagnostic Message	Failure	Do This:	Refer To:
<i>COIN MECH SENSOR ERROR</i>	The main controller does not read the coin level sensors.	1. Check that the proper coin mechanism is configured in the machine.	<i>Operators' Guide</i>
		2. Replace the coin mechanism.	
		3. Replace the cable from the coin mechanism to the main controller.	
<i>COIN MECH NO POWER UP or COIN MECH NO DATA</i>		1. Verify that the coin mechanism is properly installed and the cable attached.	
		2. Check the machine for correct coin mechanism configuration.	
		3. Check the coin PCB fuse.	
		4. Replace the coin mechanism.	
		5. Replace the main controller.	Controller PCB on page 57
<i>DBV COMM</i>	Incomplete bill validator communications.	1. Verify machine is properly programmed. At least one bill denomination must be configured for this to work properly.	<i>Operators' Guide</i>
		2. Check harness connections; check to see if the correct harness for the validator is present. <ul style="list-style-type: none"> a. Pulse validators use a harness connected to controller PCB at J42. b. Serial validators use a harness connected to controller PCB at J41. c. Both types of validators get power from J102. d. Replace harnesses as required.interface PCB 	

Model 431 Shoppertron Troubleshooting and Repair Guide

Table 2 Possible Failures (Diagnostic Messages) - Continued

Diagnostic Message	Failure	Do This:	Refer To:
<i>HEALTH OFF</i>	Machine out of service because the health control temperature has risen above 45 degrees F for more than the allotted time.	1. Check details of occurrence and any power failure problems in data.	<i>Operators' Guide</i>
		2. Press  and read the current operating temperature in the cabinet. Verify the temperature with a thermometer.	Refer to the <i>Operators' Guide</i> for more information.
		3. Investigate any refrigeration problems.	
<i>INSIDE KEY</i>		1. Replace the service keypad	Service Keypad on page 60
		2. Replace the main controller.	Controller PCB on page 57
<i>KEYPAD XY</i>	Key(s) xy is stuck (xy will be replaced by the symbols for the stuck keys).	1. Try to release the selection / service switch or replace the membrane	Direction Switch on page 61, or Service Keypad on page 60
<i>LEFT KEY</i> or <i>RIGHT KEY</i>		1. Replace the direction switch.	Direction Switch on page 61
<i>MECH COMM</i>	Incomplete communications with the coin mechanism.	1. Check connection between the power panel and the coin mechanism. 2. Check the coin mechanism harness at the black Jones plug, and at J40 on the controller PCB. 3. Replace the coin mechanism.	
<i>MECH SENSOR</i>	Bad tube sensor in the coin mechanism.	Replace the coin mechanism.	



Model 431 Shoppertron Troubleshooting and Repair Guide

Table 2 Possible Failures (Diagnostic Messages) - Continued

Diagnostic Message	Failure	Do This:	Refer To:
<i>MOTOR JAM</i>	Motor movement (MOTION) is not detected in either direction	1. Repeat the above solenoid & switch test to ensure that the drum turns correctly.	
		2. If the drum rocks back and forth, check connection at motion sensor J193 and interface PCB J59. a. Replace motion sensor. b. Replace interface PCB.	Motion Sensor System on page 56
		3. If the motor does not run - test power to the motor when the solenoid switch is made: a. J58, pins 2 or 3 = 120 vac output to either motor winding.	
		4. If the motor runs, check that the WHEEL is fixed solidly to the motor shaft and turns properly.	Motion Sensor System on page 56
		5. See <i>NO WHEEL</i> . Complete the motion sensor input test to interface PCB.	
<i>MOTOR JAM</i> (Continued)		6. Replace the interface PCB.	Interface PCB and Dumb Mech Power Supply PCB on page 43

Model 431 Shoppertron Troubleshooting and Repair Guide

Table 2 Possible Failures (Diagnostic Messages) - Continued

Diagnostic Message	Failure	Do This:	Refer To:
<i>MOTOR ERROR DIRECTION</i>	Drum turns only one direction.	1. Check to see if the arrow keys operate correctly: a. Press both keys. Does the display show the temperature? b. Press either key. If the display shows the temperature, replace the direction switch.	Direction Switch on page 61
		2. Check for good contact at connections J58 on the interface PCB and at the motor.	
		3. Replace the motor direction capacitor.	Triac/Drum Motor Capacitor on page 59
		4. Replace the interface PCB.	Interface PCB and Dumb Mech Power Supply PCB on page 43
		5. Replace the motor.	Drive Motor Assembly on page 45
<i>NO ERRORS</i>	None of the above errors are detected.	None	
<i>NO MECH</i>	Coin mechanism is not detected.	1. Press  and  to read coin mechanism options.	
		2. Check fuse and ALL connections from main controller to coin mechanism. If connections are good, replace coin mechanism.	

Model 431 Shoppertron Troubleshooting and Repair Guide

Table 2 Possible Failures (Diagnostic Messages) - Continued

Diagnostic Message	Failure	Do This:	Refer To:
<i>NO WHEEL</i>	No valid input from the motion sensor to interface PCB, J59, pin 6, when the solenoid switch input was recorded.	1. Repeat the <i>MOTOR JAM</i> tests.	<i>MOTOR JAM</i> on page 34
		2. Test the motion sensor input to the interface PCB at J59, Pin 6: <ol style="list-style-type: none"> a. Wheel is stationary, +10 vdc Wheel is passing light or blocking light, 0 vdc. b. Use the loading switch to run the motor (& wheel) to see a MEAN voltage of +5 vdc. 	
		3. If test fails, replace the motion sensor	Motion Sensor System on page 56
		4. If test passes, replace the interface PCB.	Interface PCB and Dumb Mech Power Supply PCB on page 43
<i>ROM ERROR</i>	Error in the EPROM.	1. Try another EPROM or replace the controller	Controller PCB on page 57
	The ROM total does not equal a preset value.	1. Reset time and other configuration information.	<i>Operators' Guide</i>
		2. Replace the EPROM.	EPROM on page 70
		3. Replace the main controller.	Controller PCB on page 57

Model 431 Shoppertron Troubleshooting and Repair Guide

Table 2 Possible Failures (Diagnostic Messages) - Continued

Diagnostic Message	Failure	Do This:	Refer To:
SOLENOID	Solenoid switch input not detected by controller. Solenoid is energized:	Open the cold door and use the loading switch to check that the solenoid will energize and the solenoid switch is made to the N/O contact.	
		1. Check all connections.	
		2. Check for proper solenoid switch adjustment; adjust as necessary.	
		3. Check switch for proper continuity; replace if necessary.	Stop Pin Solenoid Assembly on page 47
		4. Check that the solenoid switch remains ON when the stop pin rides on the drum track, thus keeping power on to the motor.	
		5. Test the switch input to the interface PCB at J59, Pin 5: a. Switch ON = +30 vdc, b. Switch OFF = 0 vdc. If present, replace interface PCB.	Interface PCB and Dumb Mech Power Supply PCB on page 43
		6. Check the ribbon cable between the interface PCB and the controller PCB. a. If bad, replace the ribbon cable. b. If ribbon cable is good, replace the interface PCB	Interface PCB and Dumb Mech Power Supply PCB on page 43
c. If ribbon cable is good, replace the controller PCB.	Controller PCB on page 57		





Model 431 Shoppertron Troubleshooting and Repair Guide

Table 2 Possible Failures (Diagnostic Messages) - Continued

Diagnostic Message	Failure	Do This:	Refer To:
SOLENOID (Continued)	Solenoid is not energized:	1. Check solenoid connections.	
		2. Check connection at interface PCB.	
		3. Check for 110 VAC at J58 pin 4. a. If present, replace solenoid.	Stop Pin Solenoid Assembly on page 47
		b. If not present, replace interface PCB.	Interface PCB and Dumb Mech Power Supply PCB on page 43
STACK FULL	The bill stacker is full.	1. Open and remove bills from the validator stacker.	
		2. Disconnect the validator from its harness. If the message does not reappear on power up, replace the stacker.	
		3. If on power up, the message does reappear, replace the main controller.	
STUCK KEYS		1. Check to ensure that the back of the keypad is not making contact with the door.	
		2. Disconnect the function pad from the main controller.	
		3. Close the monetary door.	
		4. If the message is not present, the service keypad is the problem.	Service Keypad on page 60
		5. Install a new credit display.	
		6. Replace the main controller.	Controller PCB on page 57

Model 431 Shoppertron Troubleshooting and Repair Guide

Table 2 Possible Failures (Diagnostic Messages) - Continued

Diagnostic Message	Failure	Do This:	Refer To:
<i>TA</i> <i>TAMPER</i> <i>123</i>	This denotes an attempt to buy from a SOLD compartment in zone 1,2 or 3 - tamper check is switched on.	1. If you do NOT require tamper check to be in use - press  and switch off tamper.	Operators' Guide
		2. If you DO require tamper check, ensure that after fully loading the machine, the controller is informed.	
<i>TEMP</i> <i>RANGE</i>	The temperature sensor is out of the acceptable range.	1. Press  to view current temperature.	Temperature Sensor on page 58 Controller PCB on page 57
		2. Try connecting a new temperature sensor.	
		3. Replace the main controller	
<i>TEMP</i> <i>REF</i>	The temperature reference at the controller cannot be read.	1. Press  to view current temperature.	Temperature Sensor on page 58 Controller PCB on page 57
		2. Try connecting a new temperature sensor	
		3. Replace the main controller	
<i>TEMP</i> <i>SENSE</i>	The temperature sensor cannot be interpreted by the controller.	1. Press  to view current temperature.	Temperature Sensor on page 58
		2. Try connecting a new temperature sensor.	

Model 431 Shoppertron Troubleshooting and Repair Guide

Table 2 Possible Failures (Diagnostic Messages) - Continued

Diagnostic Message	Failure	Do This:	Refer To:
TEMP. XX		1. Press  to view the temperature inside the machine.	
		2. If the temperature reading is 00, check to be sure that the temperature probe is plugged in.	
		3. Using a known good thermometer, measure the internal temperature and check the difference between the two readings.	
		a. If the difference is greater than 2 degrees, replace the temperature sensor.	Temperature Sensor on page 58

Note** With any of the above temperature control problems - carefully check **ALL** connections. Refer to the wiring diagrams.

Section V. Removal and Replacement Procedures

1. General Information

These procedures are intended to aid in removing and replacing some major assemblies in your merchandiser. Some things to remember:

- Unless you are testing for voltages, always unplug your merchandiser prior to starting work.
- Always follow proper shop practices.
- Wear eye protection at all times while working on equipment.
- Get help when lifting heavy objects.

Model 431 Shoppertron Troubleshooting and Repair Guide

A. Duct and Blower Assembly

Removal

WARNING
Prior to working on the machine, be sure it is unplugged from its power source.

1. Remove two screws that secure the cover (figure 2). Remove the cover.
2. Disconnect the wires from the blower motor.
3. The two black painted screws in the “Z” channel under the duct and blower assembly hold the duct and blower assembly secure against the door front. Loosen them about 1 turn each (you may need to loosen them up more later).
4. Remove the two screws up under the front lip of the duct and blower assembly (figure 2).
5. Pivot the duct and blower assembly toward you. To do this, you might have to slightly pry the top lip of the assembly down to allow it to clear some screws.
6. Lift the duct and blower assembly out of the “Z” channel (you may need to further loosen the two screws under the duct and blower assembly).
7. To remove the blower motor, remove the two screws securing the motor to the duct assembly (figure 3).

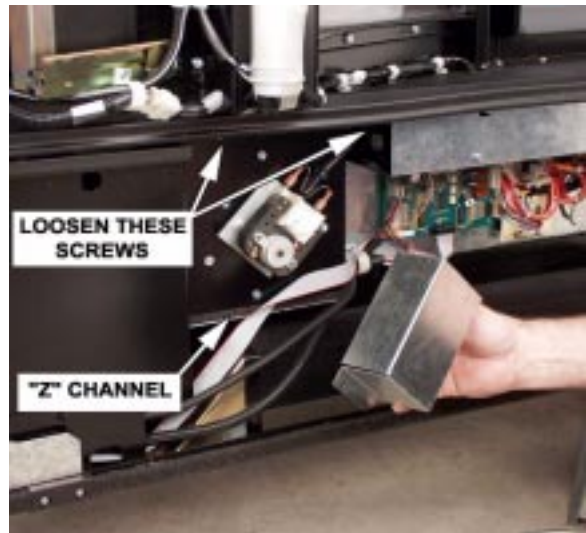

Figure 2

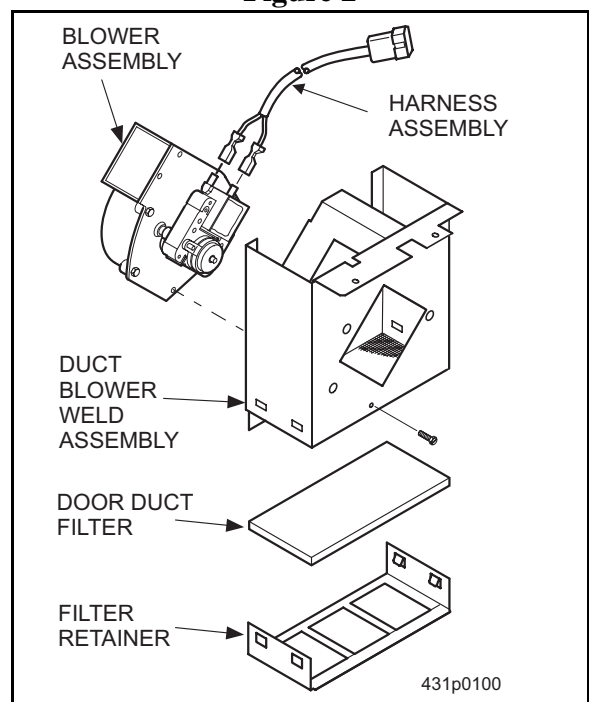

Figure 3

Replacement

1. If the motor was removed, install it into the duct assembly, and secure it with two screws.
2. Hook the flange on the lower rear of the duct and blower assembly into the “Z” channel.
3. Pivot the duct and blower motor assembly up until the mounting holes in the top of the duct assembly line up with the screw holes in the machine door.
4. Secure the duct and blower assembly to the door with two screws.
5. Tighten the two black screws into the “Z” channel (under the duct and blower assembly). This will secure the duct and blower assembly tightly against the machine door.
6. Connect the two wires to the blower motor.
7. Mount the cover to the front of the duct and blower assembly and secure with two screws.

Model 431 Shoppertron Troubleshooting and Repair Guide

B. Interface PCB and Dumb Mech Power Supply PCB

Removal

WARNING

Prior to working on the machine, be sure it is unplugged from its power source.

CAUTION

These PCB assemblies are susceptible to electronic static discharge (ESD) damage. Take proper precautions as outlined in this manual.

1. The two black painted screws in the "Z" channel under the lower door electronics assembly hold the lower door electronics assembly secure against the door front. Loosen the two screws about 1 turn each (you may need to loosen them up more later).
2. Loosen the two screws that secure the cover. Remove the cover by sliding it to one side and pivoting it down and towards you (figure 4).

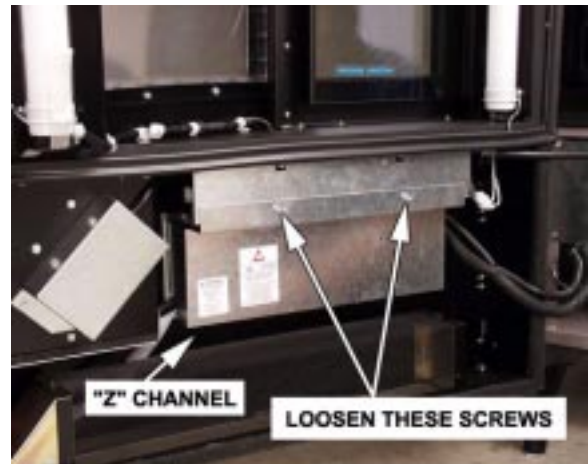

Figure 4

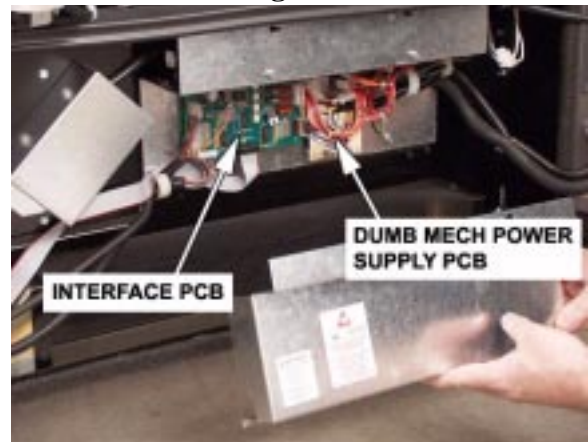

Figure 5

3. Mark all electrical connections to the PCB to make it easier to reconnect them later (figure 6).
4. Disconnect all electrical connectors from the PCB.
5. Remove the screws holding the PCB to the lower door electronics assembly.

Model 431 Shoppertron Troubleshooting and Repair Guide

Replacement

1. Attach the PCB to the lower door electronics assembly.
2. Connect all electrical connections as they were originally.
3. Hook the bottom of the cover into the “Z” channel under the lower door electronics assembly.
4. Pivot the cover up and away from you until the slots in the cover are captured by the two screws.
5. Tighten the screws to secure the cover.
6. Tighten the two black screws into the “Z” channel. This will secure the lower door electronics assembly tightly against the machine door.

Fluorescent Lamp Electrical Assembly Access

7. The two black painted screws in the “Z” channel under the lower door electronics assembly hold the lower door electronics assembly secure against the door front. Loosen the two screws about 1 turn each (you may need to loosen them up more later).
8. Loosen the upper two screws securing the lower door electronics assembly to the door, as shown (figure 6).
9. Pivot the lower door electronics assembly toward you.
10. Remove affected component (figure 7).

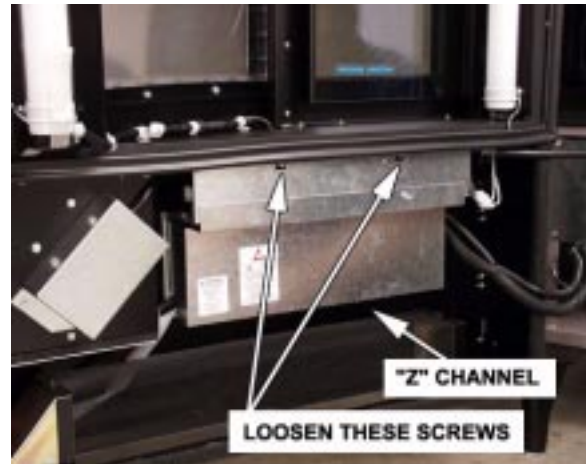

Figure 6

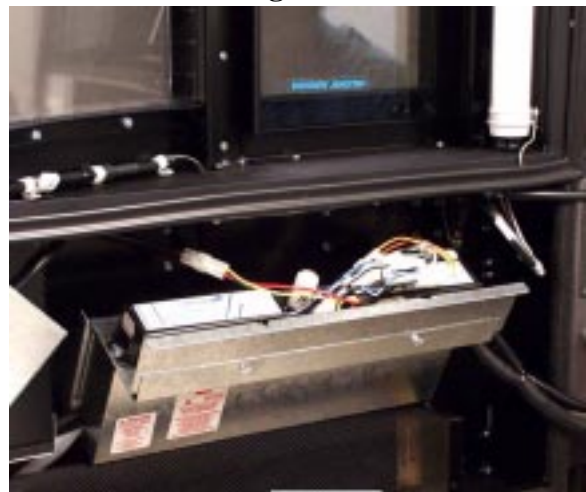

Figure 7

Model 431 Shoppertron Troubleshooting and Repair Guide

C. Drive Motor Assembly

Removal

WARNING

Prior to working on the machine, be sure it is unplugged from its power source.

1. Remove the three screws securing the cover; remove the cover (figure 8).
2. Disconnect electrical cables, and remove from any clamps.
3. Remove the two screws at the rear of the motor assembly which secure the motor assembly to the machine.
4. While supporting the drive motor assembly with one hand, remove the single front screw securing it to the machine (figure 9).
5. Remove the assembly by lowering it and turning it until it is free of the machine.

Replacement

1. Lift the drive motor assembly into place. You may have to turn the cooling fan on the bottom of the assembly until the shaft and its drive pins mate with the drive gear shaft.
2. Secure the drive motor assembly with one screw in front.
3. Install the two screws at the rear of the drive motor assembly.
4. Connect the wiring harnesses.
5. Install the cover. Secure it with three screws.
6. Install the cable into the clamp.

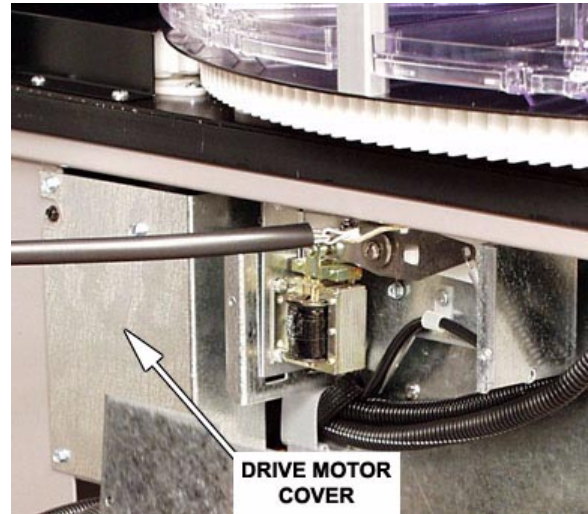

Figure 8

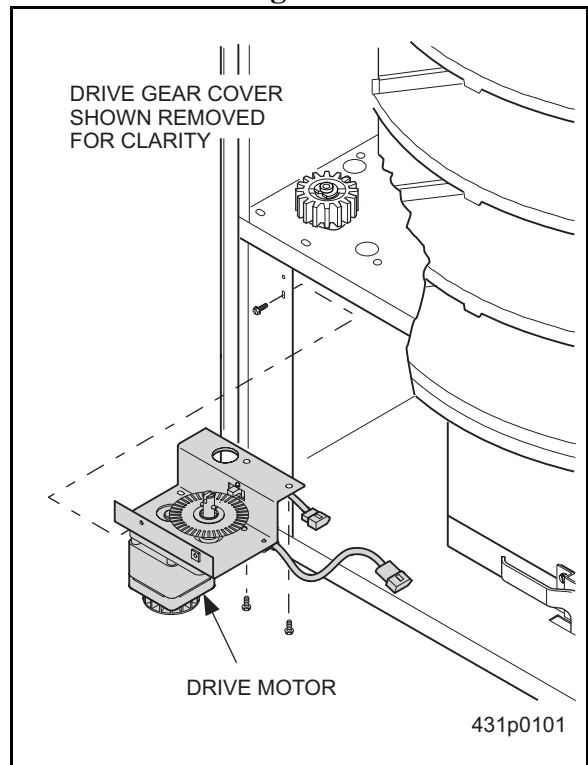

Figure 9

Model 431 Shoppertron Troubleshooting and Repair Guide

D. Power Panel Assembly

Removal

WARNING

Prior to working on the machine, be sure it is unplugged from its power source.

1. Remove the two screws securing the power panel (figure 10).
2. Pull the power panel straight toward you.
3. Disconnect the following (figure 11):
 - a. The black and white wires (L1 & L2) from the main power switch,
 - b. The screw securing the green ground wire to the power panel chassis.
 - c. The refrigeration assembly connector.
4. Remove the power panel assembly.

Replacement

1. Connect the wires previously removed.
2. Move the power panel into place.
3. Secure with two screws.



Figure 10



Figure 11

Model 431 Shoppertron Troubleshooting and Repair Guide

E. Stop Pin Solenoid Assembly

Removal

WARNING

Prior to working on the machine, be sure it is unplugged from its power source.

1. Open the wire harness clamp securing the harness to the stop pin solenoid. Remove the harness from the clamp.
2. Remove the two screws securing the cover (figure 12).
3. Disconnect wiring harnesses from the stop pin solenoid assembly (figure 13).
4. Remove the three screws on the top. **DO NOT** loosen any other screws (figure 13).
5. Lower the stop pin solenoid assembly and remove from the machine.



Figure 12



Figure 13

Model 431 Shoppertron Troubleshooting and Repair Guide

Replacement

NOTE

While the stop pin solenoid assembly can be adjusted in place, it is easier to do it prior to mounting.

1. Adjust the stop pin solenoid as follows (figure 14):
 - a. Loosen both stop switch mounting screws as shown.
 - b. Pull the stop pin down and rotate the drum by hand so the pin rides on the bottom of the drum stop plates.
 - c. Place a .078 thick shim (or use approximately one to two dimes) under the plunger of the solenoid.
 - d. Push up on the bottom of the solenoid to raise the assembly to the working position.
 - e. Rotate the drum by hand until the stop pin seats into a hole. Remove the shim(s).
 - f. Unhook one end of the spring.
 - g. Rotate the stop delay cam until the switch roller rides on the cam high point just below the cam dimple.
 - h. Rotate the switch until the switch roller bracket just bottoms out on the switch housing.
 - i. Tighten the switch mounting screws.
 - j. Replace the spring.
2. Raise the stop pin solenoid assembly into place.
3. Secure with three screws.

NOTE

Prior to performing the next step, you may want to verify the proper operation of the stop pin solenoid assembly. If it does not work properly, repeat step 1.

4. Secure the cover to the stop pin solenoid assembly.
5. Place the harness in the wire harness clamp and close the clamp.

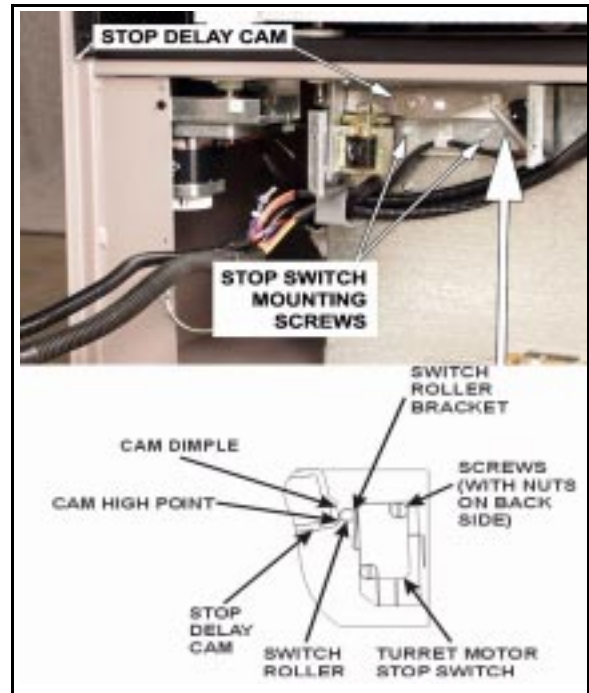

Figure 14

Model 431 Shoppertron Troubleshooting and Repair Guide

F. Refrigeration Unit

Removal

WARNING

Prior to working on the machine, be sure it is unplugged from its power source.

CAUTION

The refrigeration unit is bulky and heavy. Use help and proper lifting techniques to avoid personal injury and/or equipment damage.

1. Remove the power panel (page 46), stop pin solenoid (page 47), and the motor assembly (page 45).
2. Remove the lower “L” bracket (figure 15).
3. Remove the screw from the latch (figure 15).
4. Turn the latch. This lowers the refrigeration unit to the floor of the machine.

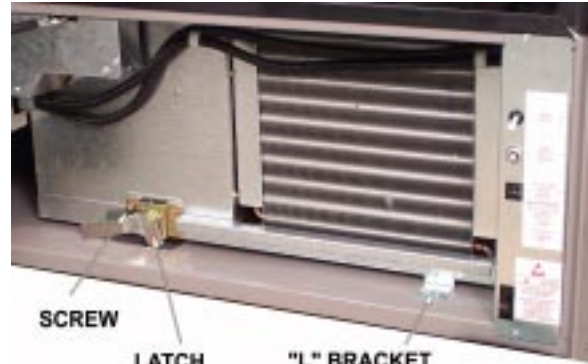

Figure 15

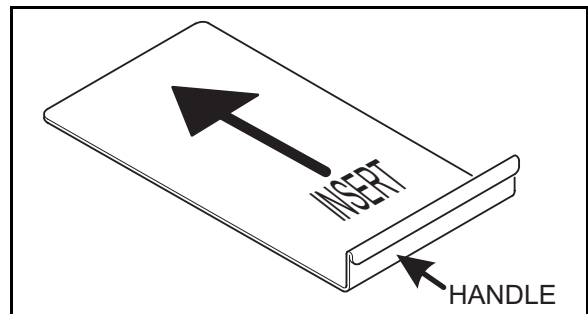

Figure 16

5. Remove the screw from the latch (figure 15).
 6. Turn the latch. This lowers the refrigeration unit to the floor of the machine.
- NOTE**
- On some older machines, you may need to use a special refrigeration removal tool (shoehorn) (figure 16). This tool is available from the Crane Merchandising Systems Parts Department (P/N 4310061). Or, it can be constructed out of a piece of sheet metal approximately 0.035 x 9.00 x 16.00 *with smooth edges*.
- a. Grasp the shoehorn by the handle and insert it above the refrigeration unit until the gasket is separated from the cabinet.
5. Pull the refrigeration unit straight out of the machine until it will “teeter” on the front lip of the machine floor.
 6. Tilt it forward, then carefully move it out until it is free of the machine.

Replacement

CAUTION

The refrigeration unit is bulky and heavy. Use help and proper lifting techniques to avoid personal injury and/or equipment damage.

1. Orient the refrigeration unit in front of the machine.
2. Lift the rear of the unit onto the machine floor.
3. Slide the refrigeration unit back until the two studs on the side of the refrigeration unit begin to ride on the tracks.

Model 431 Shoppertron Troubleshooting and Repair Guide

4. Push the unit all the way back until it begins to ride up the ramps. The gasket on the unit will mate with the ductwork above. Take care not to deform or damage the gasket. When the refrigeration unit is far enough back into the machine, turn the latch down. This will lift the front of the refrigeration unit up to complete sealing the gasket to the machine.
5. Install the screw in the latch to prevent it from moving.
6. Replace the lower “L” bracket.
7. Replace the power panel (page 46), stop pin solenoid (page 48), and the motor assembly (page 45).

G. Refrigeration Compressor Components

WARNING

Prior to working on the machine, be sure it is unplugged from its power source.

1. Remove the refrigeration unit (page 49).
2. Remove covers from the compressor components as required for access (figure 17).
3. Change components as required.
4. Replace refrigeration unit (page 49).

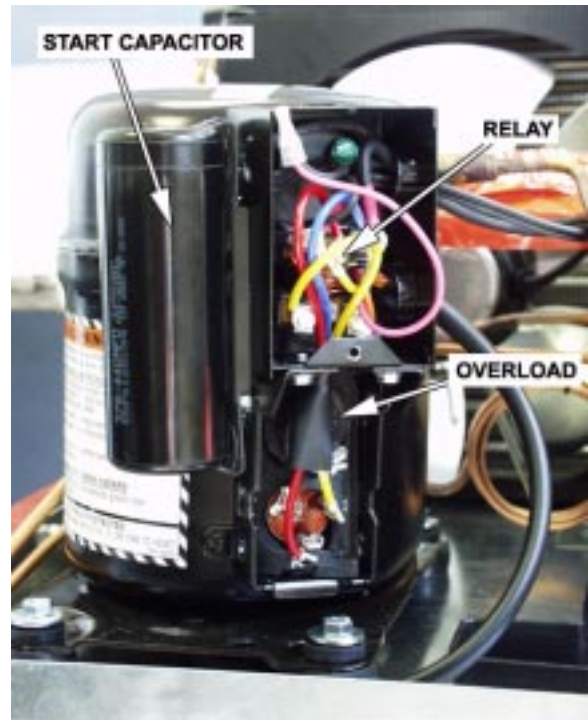

Figure 17

Model 431 Shoppertron Troubleshooting and Repair Guide

H. Fluorescent Light Assembly

Removal

WARNING

Prior to working on the machine, be sure it is unplugged from its power source.

1. Remove both the temperature probe and load switch harnesses from the “J” clamp and set them aside (figure 18).
2. Unplug the fluorescent light harness located at the bottom center of the last vend door and remove the harness from the two “J” clamps.
3. Disconnect the 15-pin Molex plug connecting the mechanism assembly to the controller PCB, located at the lower right corner of the mechanism assembly.
4. Loosen the two 1/4” hex head screws securing the fluorescent light assembly and remove the cover (figure 19). Set it off to one side ensuring that the bulb doesn’t break.

CAUTION

Do not use the fluorescent light as a handle to remove the cover.

Replacement

1. Replace the fluorescent light assembly shield. Secure it with the two 1/4” screws removed earlier.
2. Replace the temperature probe and loading switch harnesses back into the “J” clamps.
3. Connect the fifteen-pin Molex plug at the lower left hand corner of the mechanism assembly.

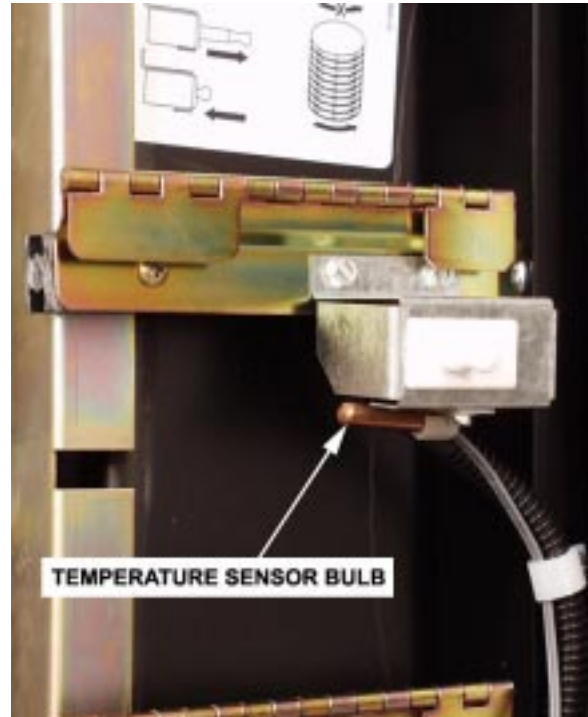

Figure 18



Figure 19

Model 431 Shoppertron Troubleshooting and Repair Guide

I. Vend Door

Removal

WARNING

Prior to working on the machine, be sure it is unplugged from its power source.

1. Remove the fluorescent light assembly (page 51)
2. Remove six 1/4" hex head screws that run the length of the left hand side of the mechanism assembly.

CAUTION

You may want to leave one screw in place at the top of the assembly to keep it in place while performing the next step.

3. Remove four of the eight 1/4" hex head screws securing the mechanism assembly to the support angle: The top one, the 4th down from the top, the 6th down from the top, and the 8th down from the top (figure 20).

NOTE

The four screws that you are removing are the ones that are NOT in an open round slot.

4. Remove the ten flat head screws from the support angle and set them aside.
5. Remove the flat head screws at both ends of the door guides (upper and lower) for the door you are replacing.
6. Remove the screw securing the spring housing to the cabinet door. Remove the spring housing (figure 21).
7. Unhook the door spring from the vend door.
8. Slide the damaged vend door to the left. Carefully remove the vend door by separating the door guides slightly.

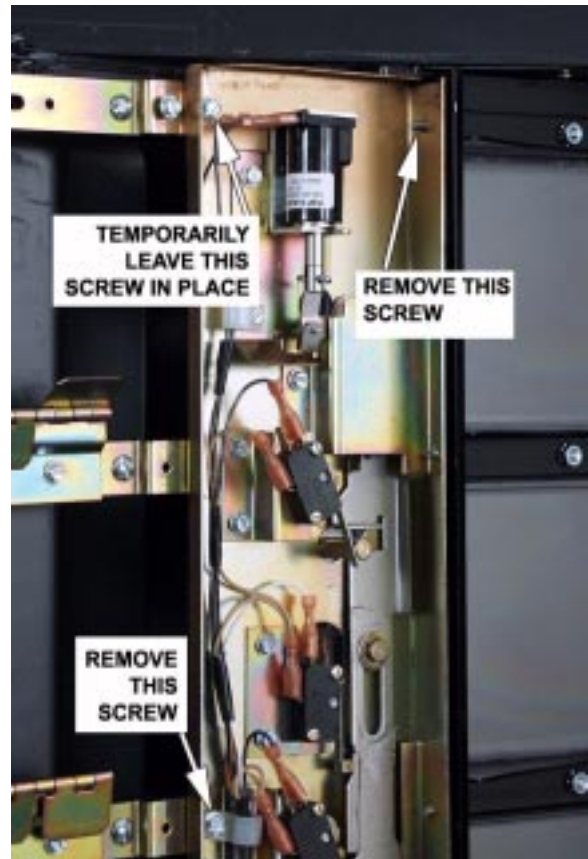

Figure 20

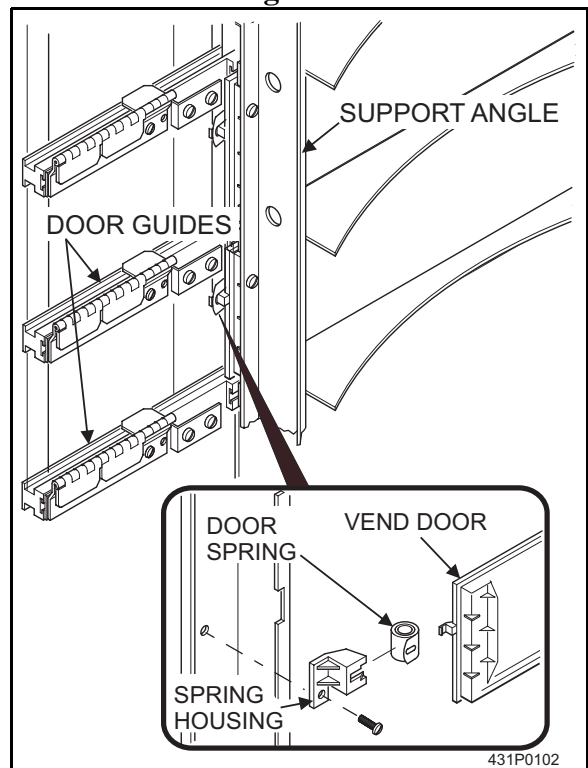

Figure 21

Model 431 Shoppertron Troubleshooting and Repair Guide

Replacement

1. Insert the new vend door into the door guides by separating them slightly.

CAUTION

It helps to use a lubricant (silicone gel or Vaseline) to lubricate the door guide, allowing the vend door to move smoothly.

2. Replace the screws at the end of the upper and lower door guides to secure them in place.
3. Hook the door spring onto the tab of the vend door.
4. Capture the door spring with the spring housing and secure it to the cabinet door with the screw removed earlier.
5. Replace the support angle with the ten flat head screws removed earlier.
6. Reposition the mechanism assembly and secure it with four 1/4" screws to the right side of the support angle (removed earlier).
7. Replace the six 1/4" screws on the left hand side of the mechanism assembly, fastening it to the main door.
8. Replace the fluorescent light assembly (page 51).

Model 431 Shoppertron Troubleshooting and Repair Guide

J. Drive Gear

Removal

WARNING

Prior to working on the machine, be sure it is unplugged from its power source.

1. Remove the two screws securing the gear cover. Remove the cover.
2. Remove the retaining ring from the top of the gear (figure 22).
3. Remove the gear from the shaft.

Replacement

1. Place gear on the shaft. If it does not seat all the way, pull it up, turn it 90 degrees, and try again.
2. Secure the gear with the retaining ring.
3. Install the cover over the gear and secure it with two screws.

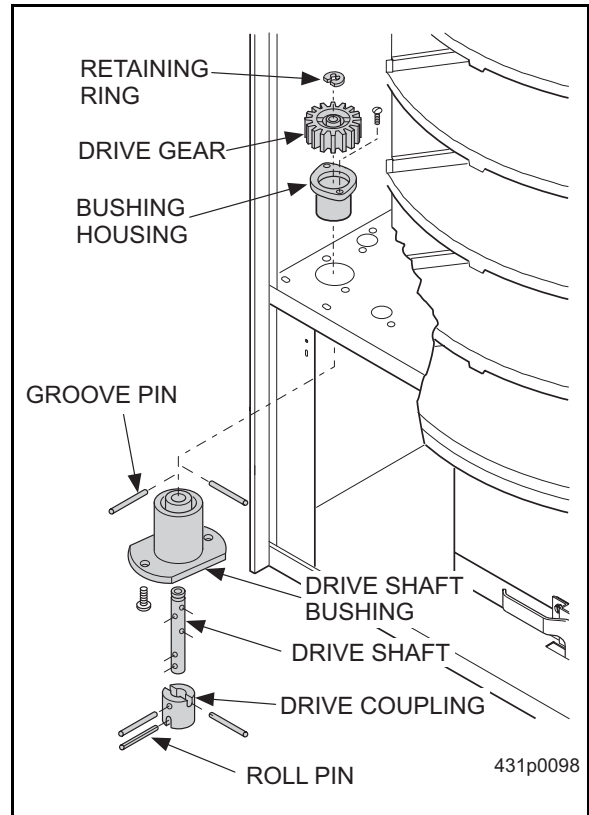

Figure 22

K. Drive Shaft Bushing

Removal

1. Remove the drive motor assembly (page 45).
2. Remove the drive gear (page 54).
3. Remove the two screws holding the bushing housing and the drive shaft bushing in place. Remove the drive shaft bushing (figure 22).
4. Remove the drive shaft from the drive shaft bushing by pushing out two roll pins.

Replacement

1. Assemble the drive shaft to the drive shaft bushing. Secure with two roll pins.
2. Install the drive shaft bushing. Secure with two screws.
3. Install the drive gear (page 54).
4. Install the drive motor assembly (page 45).

Model 431 Shoppertron Troubleshooting and Repair Guide

L. Proximity Sensor (Home Switch)

Removal

WARNING

Prior to working on the machine, be sure it is unplugged from its power source.

1. Disconnect the proximity sensor wiring harness.
2. Remove two screws securing the sensor plate (figure 23).
3. While pulling up on the sensor plate, carefully push the small insulation plug from the hole the wiring harness is routed through.
4. Remove the sensor plate and proximity sensor from the machine.
5. Mark the location of the proximity sensor on the sensor plate.
6. Remove two screws from the proximity sensor. Remove the sensor.

Replacement

1. Mount the proximity sensor on the sensor plate. Secure with two screws.
2. Put the wiring harness through the slot in the insulation plug.
3. Route the wiring harness through the hole in the machine while inserting the insulation plug in the hole.
4. Secure the sensor plate to the machine with two screws.

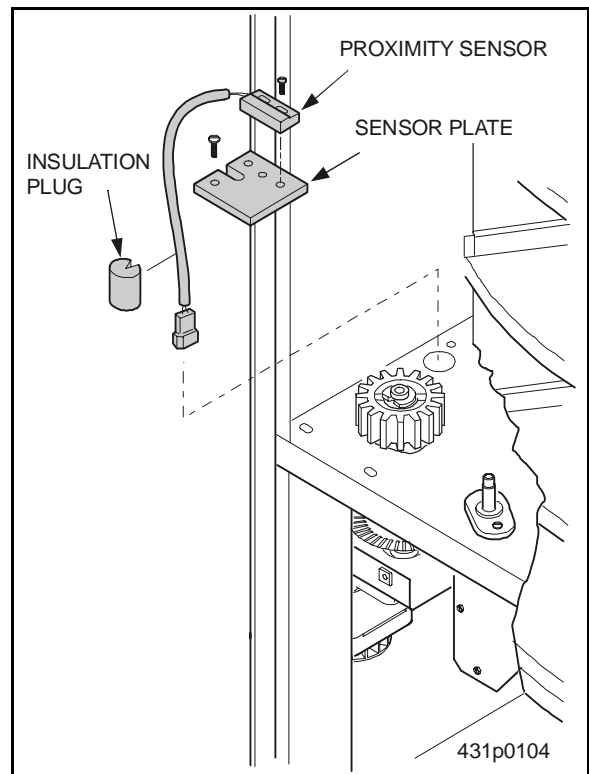

Figure 23

Model 431 Shoppertron Troubleshooting and Repair Guide

M. Motion Sensor System

Removal

WARNING

Prior to working on the machine, be sure it is unplugged from its power source.

1. Remove the drive motor assembly (page 45).

NOTE

Perform only as much of this procedure as needed to remove the affected part.

2. Remove the two screws securing the motion sensor to the motor bracket. Remove the motion sensor (figure 24).
3. Remove the groove pin from the motor shaft.
4. Loosen the set screw in the optical switch wheel assembly. Remove the wheel.

Replacement

1. Install the optical switch wheel assembly over the motor shaft. Secure with the set screw.
2. Push the groove pin back into the motor shaft.
3. Install the motion sensor to the motor bracket. Secure with two screws.
4. Replace the drive motor assembly (page 45).

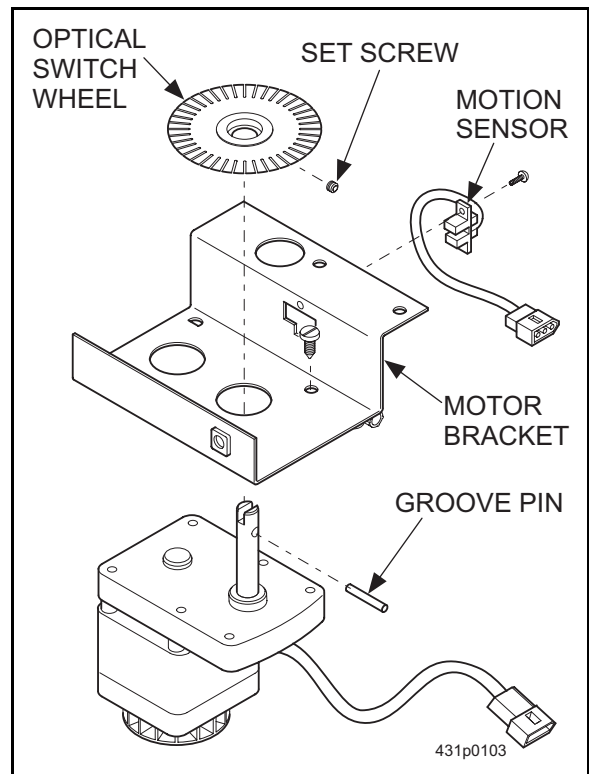

Figure 24

Model 431 Shoppertron Troubleshooting and Repair Guide

N. Controller PCB

Removal

WARNING

Prior to working on the machine, be sure it is unplugged from its power source.

1. Loosen the two screws securing the cover to the monetary compartment.
2. Slide the cover out of the way.
3. Make note of the locations of all wiring harnesses routed to this PCB.
4. Disconnect all wiring harnesses from the controller PCB.

NOTE

The controller PCB is secured to the monetary compartment with one screw-mounted standoff and several split end nylon standoffs (figure 25).

5. Remove the screw securing the controller PCB to the monetary compartment.
6. Using the appropriate tool, pinch the ends of each of the split-end standoffs together and remove the controller PCB.
7. If necessary, remove the EPROM (page 70).

Replacement

1. Install the EPROM, if it was removed (page 70).
2. Snap the controller PCB onto the split-end standoffs.
3. Secure the controller PCB with one screw into the screw mounted standoff.
4. Connect all wiring harnesses to the controller PCB.
5. Replace the cover, and secure with two screws.

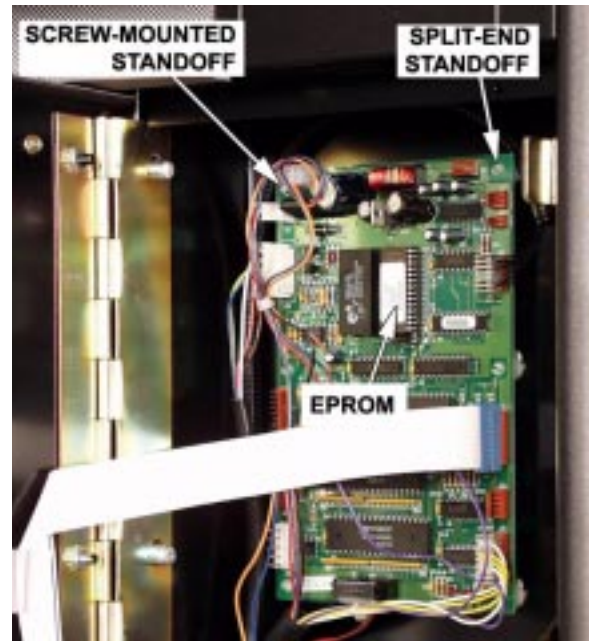

Figure 25

Model 431 Shoppertron Troubleshooting and Repair Guide

O. Temperature Sensor

Removal

WARNING

Prior to working on the machine, be sure it is unplugged from its power source.

1. From the front of the door, disconnect temperature sensor connector from the wiring harness.
2. Remove the temperature sensor leads from any wire clips.
3. Loosen the screw holding the temperature sensor bulb under the load switch (figure 26).
4. Remove the RTV from the wiring that passes through the door.
5. From the front of the door, pull the temperature sensor leads through the access hole.

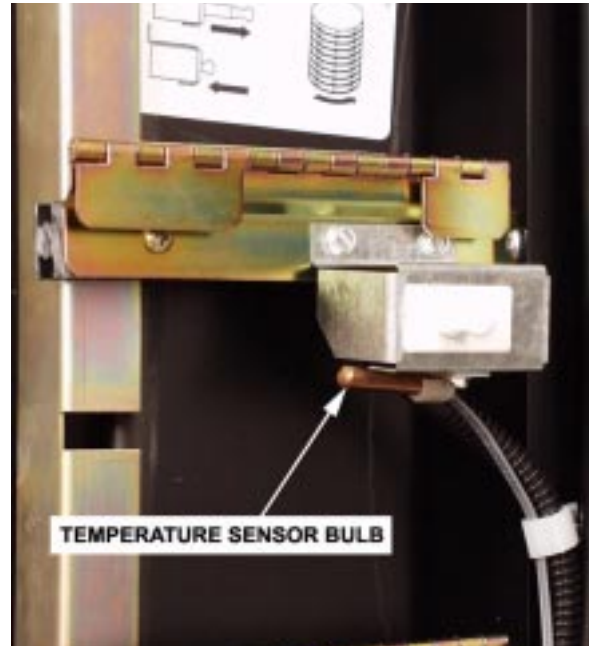

Figure 26

Replacement

1. From the front of the door, feed the bulb of the temperature sensor through the access hole.
2. Secure the temperature sensor bulb under the load switch.
3. Plug the temperature sensor into the wiring harness.
4. Route the temperature sensor lead through the wire clips.
5. Apply new RTV sealant to the access hole.

Model 431 Shoppertron Troubleshooting and Repair Guide

P. Triac/Drum Motor Capacitor

Removal

WARNING

Prior to working on the machine, be sure it is unplugged from its power source.

1. The two black painted screws in the “Z” channel under the lower door electronics assembly hold the lower door electronics assembly secure against the door front. Loosen the two screws about 1 turn each (you may need to loosen them up more later) (figure 27).
2. Loosen the two screws that secure the cover. Remove the cover by sliding it to one side and pivoting it down and towards you (figure 27).
3. Remove the electrical leads from the component.
4. Remove the component.

Replacement

1. Install the new component.
2. Connect the electrical leads as they were before.
3. Hook the bottom of the cover into the “Z” channel under the lower door electronics assembly.
4. Pivot the cover up and away from you until the slots in the cover are captured by the two screws.
5. Tighten the screws to secure the cover.
6. Tighten the two black screws into the “Z” channel. This will secure the lower door electronics assembly tightly against the machine door.

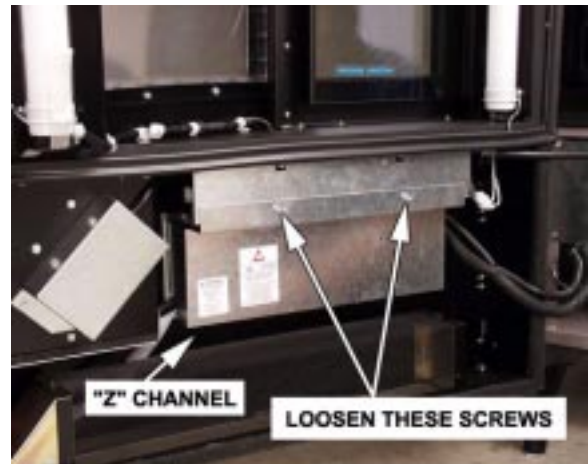

Figure 27

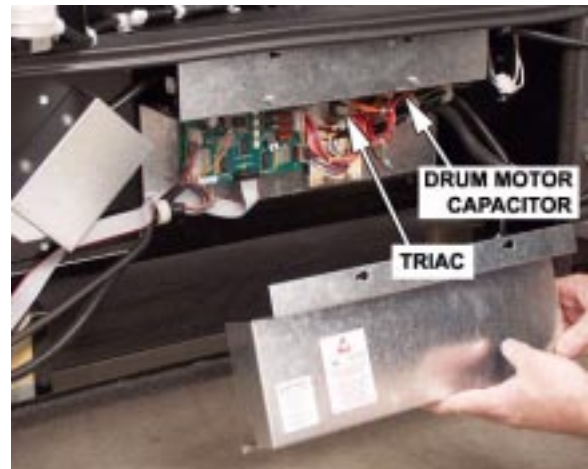

Figure 28

Model 431 Shoppertron Troubleshooting and Repair Guide

Q. Service Keypad

Removal

WARNING

Prior to working on the machine, be sure it is unplugged from its power source.

1. Disconnect the ribbon cable from the display PCB.
2. Remove the two screws that secure the service keypad and PCB mounting bracket assembly to the door, and remove.

Replacement

1. Mount the service keypad and PCB mounting bracket assembly onto the door. Secure with two screws.
2. Connect the ribbon cable to the display PCB.



Figure 29

Model 431 Shoppertron Troubleshooting and Repair Guide

R. Direction Switch

Removal

WARNING

Prior to working on the machine, be sure it is unplugged from its power source.

1. Remove the service keypad (page 60).
2. Disconnect the ribbon cable from the display PCB assembly (figure 30).
3. On Millennium Style machines, remove the screws securing the panel cover trim piece to the front of the monetary door.
4. Remove the screws securing the push button bezel to the front of the monetary door (figure 31). Remove the bezel.
5. Remove the membrane direction sheet, shim plate, pushbutton arrow sheet, pushbutton lenses, button housing assembly, and upper insert instructions.

Replacement

1. Install the membrane direction sheet, shim plate, pushbutton arrow sheet, pushbutton lenses, and button housing assembly.
2. Install the bezel to the front of the monetary door. Secure with two screws.
3. On Millennium Style machines, install the panel cover trim piece to the front of the monetary door. Secure with the screws removed earlier.
4. Connect the ribbon cable to the display PCB assembly.
5. Replace the service keypad (page 60).

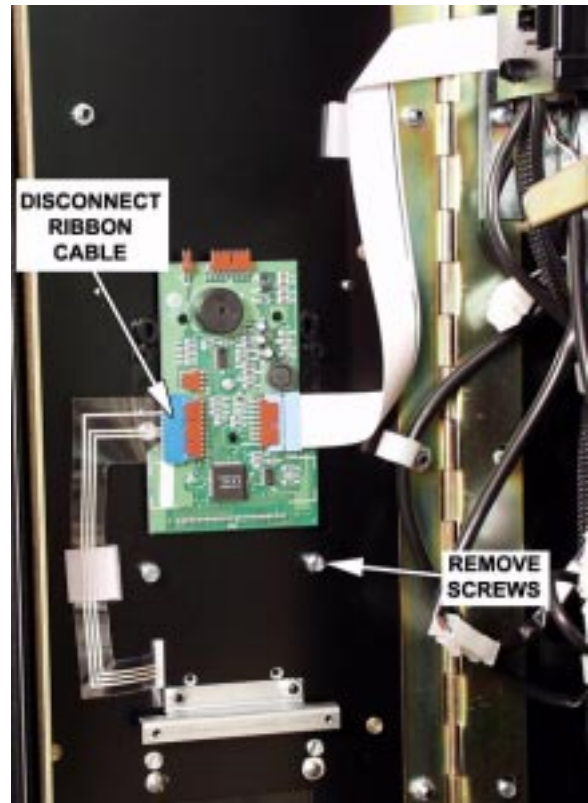

Figure 30

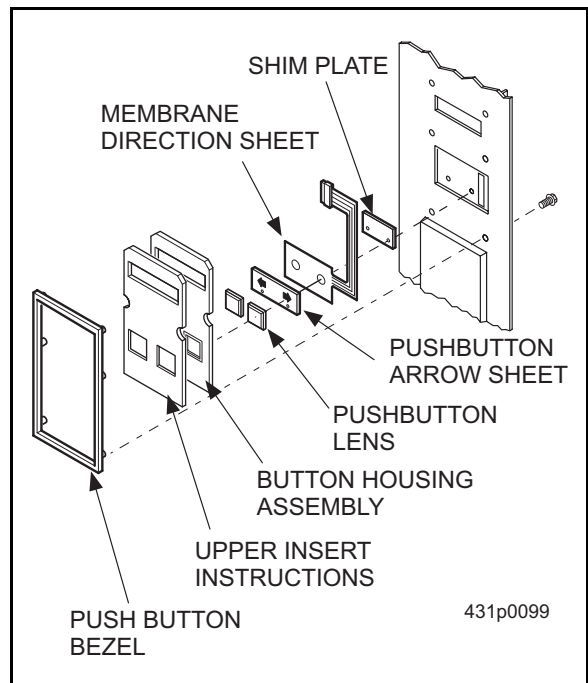

Figure 31

Model 431 Shoppertron Troubleshooting and Repair Guide

S. Credit Display Assembly

Removal

WARNING

Prior to working on the machine, be sure it is unplugged from its power source.

1. Remove the service keypad assembly (page 60).
2. Disconnect the ribbon cables coming from the direction keypad and the controller PCB (figure 32).
3. Remove the two screws holding the display PCB/bracket assembly to the monetary door, and remove.

Replacement

1. Mount the display PCB/bracket assembly to the monetary door. Secure with two screws.
2. Connect the ribbon cables from the controller PCB and the direction switch.
3. Install the service keypad assembly (page 60).

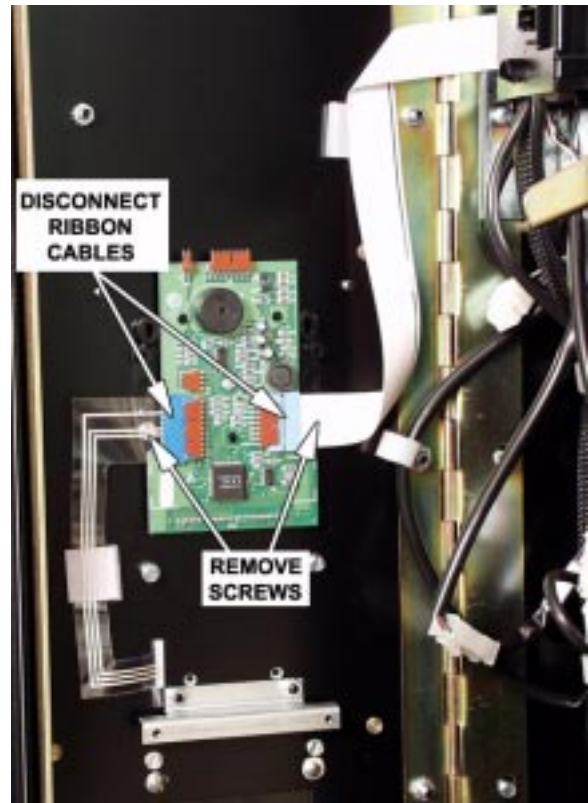

Figure 32

Model 431 Shoppertron Troubleshooting and Repair Guide

T. Turret Assembly

Removal

WARNING

Prior to working on the machine, be sure it is unplugged from its power source.

1. Remove all products from the turret.

WARNING

The turret is heavy and awkward to remove by one person. To avoid personal injury or equipment damage, this procedure should be performed by no fewer than two people.

2. Loosen the screws holding the door support channel to the door (figure 33), allowing the door support channel to drop down and contact the floor.

WARNING

THE NEXT STEP IS VERY IMPORTANT. Once the turret is removed from the cabinet, the weight of the door may cause the entire machine to tip toward you, causing potential injury or death.

3. When the door support channel is as far down as it will go, tighten the two screws securely. The door support channel **MUST** be able to hold up the door without sliding upwards (figure 34).

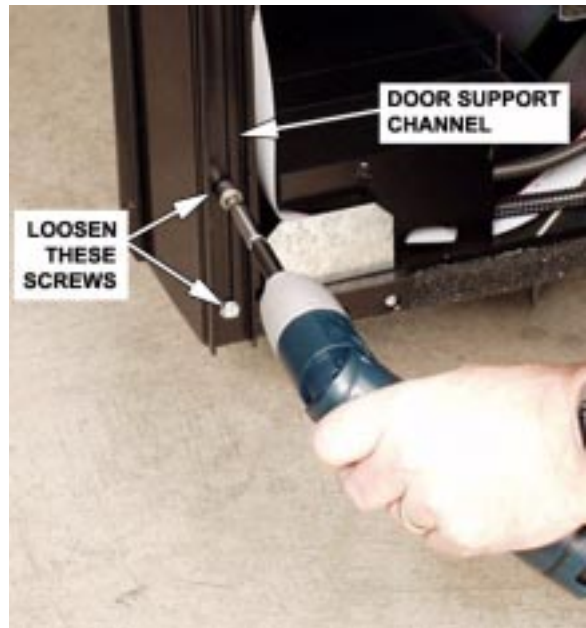

Figure 33



Figure 34

Model 431 Shoppertron Troubleshooting and Repair Guide

4. Remove the two screws securing the bearing support bracket to the inside of the cabinet (figure 35).
5. Lift straight upwards on the turret to free it from the bearing assembly in the bottom of the cabinet.

CAUTION

The turret has parts on the bottom that could be damaged by rough handling.

6. Remove the turret from the cabinet and gently set it on the floor (figure 36).

NOTE

Further disassembly of the turret is straightforward, with one exception. A small magnet is mounted on one of the sector gears (figure 37). This magnet actuates the proximity switch, and must always be mounted in the same location on the turret. Therefore, if you remove that sector gear, be sure to replace it so the magnet is immediately to the left of zone 1.

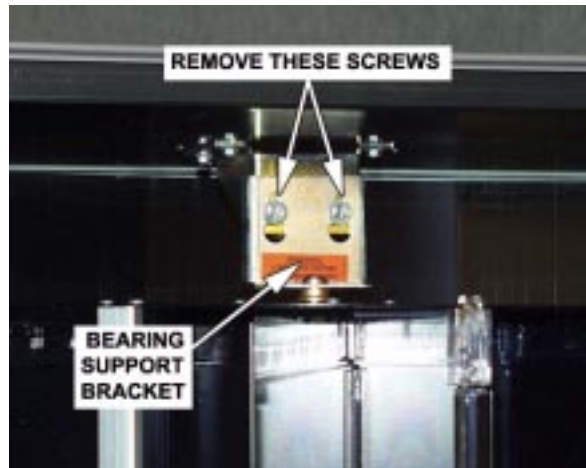

Figure 35



Figure 36

Model 431 Shoppertron Troubleshooting and Repair Guide

Replacement

WARNING

The turret is heavy and awkward to remove by one person. To avoid personal injury or equipment damage, this procedure should be performed by no fewer than two people.

1. Lift the turret into the cabinet and carefully set it down on the bearing assembly.
2. Slip the bearing support bracket onto the shaft on the top of the turret.
3. Secure the bearing support bracket to the inside of the cabinet using the two screws and washers removed previously.

U. Load Switch Assembly

Removal

WARNING

Prior to working on the machine, be sure it is unplugged from its power source.

1. Disconnect the wiring harness from the load switch.
2. Remove the screw securing the temperature sensor bulb to the load switch bracket. Remove the temperature sensor bulb.

3. Remove the two screws securing the load switch bracket to the door. Remove the load switch and load switch bracket assembly.
4. Remove the load switch from the bracket.

Replacement

1. Install the new load switch in the bracket.
2. Secure the load switch bracket assembly to the door with the two screws previously removed.
3. Secure the temperature sensor bulb to the load switch bracket with the screw previously removed.
4. Connect the wiring harness to the load switch.

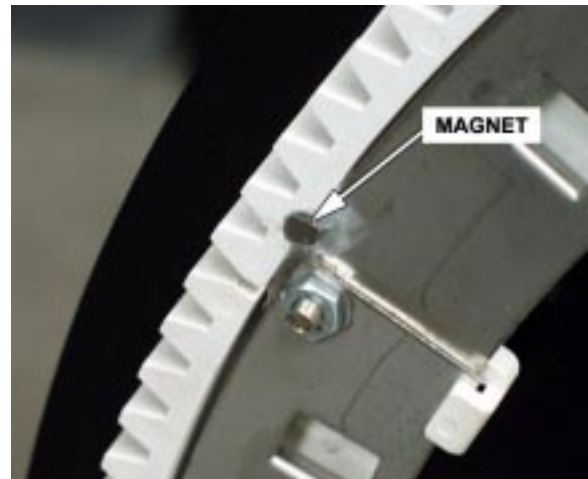

Figure 37

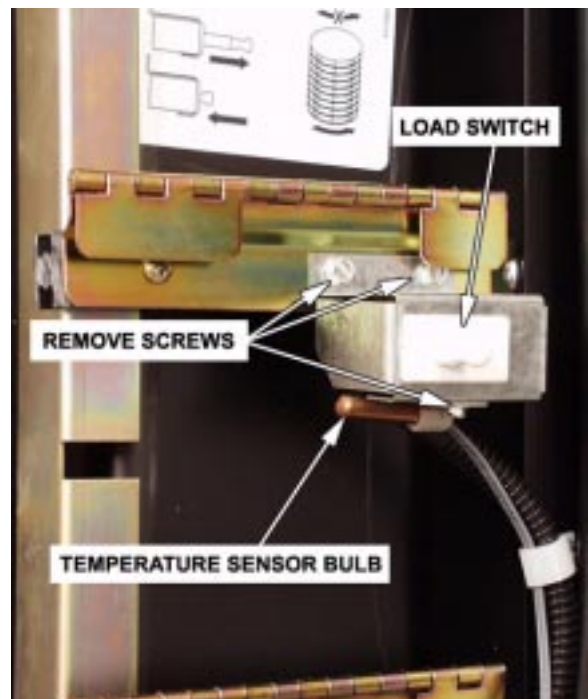

Figure 38

Model 431 Shoppertron Troubleshooting and Repair Guide

V. Lock Bar Solenoid Assembly

Removal

WARNING

Prior to working on the machine, be sure it is unplugged from its power source.

1. Remove the fluorescent light assembly (page 51).
2. Disconnect the electrical leads from the lock bar solenoid assembly (figure 39).
3. Remove the cotter pin that secures the lock bar solenoid assembly to the lock bar.
4. Remove the two screws securing the lock bar solenoid assembly. Remove the lock bar solenoid.

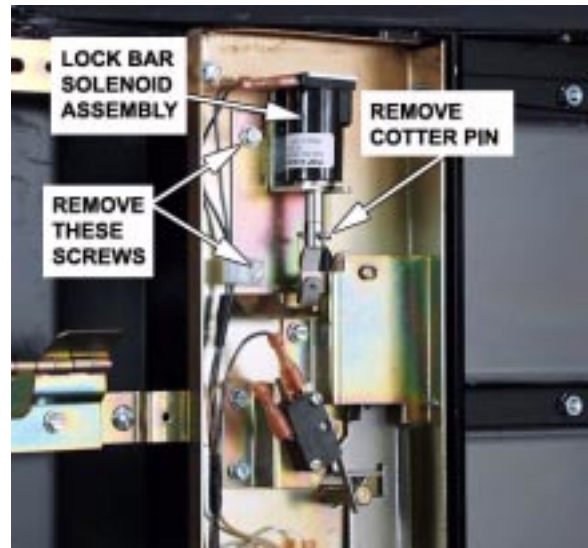

Figure 39

Replacement

1. Install a new lock bar solenoid assembly. Secure with the two screws previously removed.
2. Couple the lock bar to the lock bar solenoid assembly and secure with the cotter pin previously removed.
3. Connect the electrical wiring to the lock bar solenoid assembly.
4. Replace the fluorescent light assembly (page 51).

Model 431 Shoppertron Troubleshooting and Repair Guide

W. Vend Door Switch

Removal

WARNING

Prior to working on the machine, be sure it is unplugged from its power source.

1. Remove the fluorescent light assembly (page 51).
2. Disconnect the electrical leads from the vend door switch (figure 40).
3. Remove the screws securing the vend door switch and switch bracket.
4. Remove the switch and bracket assembly.
5. Remove the switch from the bracket.

Replacement

1. Attach the new switch to the bracket.
2. Install the switch and bracket assembly with the two screws previously removed.
3. Connect the electrical leads to the vend door switch.
4. Install the fluorescent light assembly (page 51).



Figure 40

Model 431 Shoppertron Troubleshooting and Repair Guide

X. Monetary Door Switch

Removal

WARNING

Prior to working on the machine, be sure it is unplugged from its power source.

1. Disconnect the electrical wires from the monetary door switch (figure 41).
2. Remove the two screws securing the monetary door switch bracket. Remove the switch and bracket assembly.
3. Remove the monetary door switch from the bracket.

Replacement

1. Insert a new monetary door switch into the monetary door switch bracket.
2. Secure the monetary door switch and bracket assembly with the two screws previously removed.
3. Connect the electrical wiring to the monetary door switch.

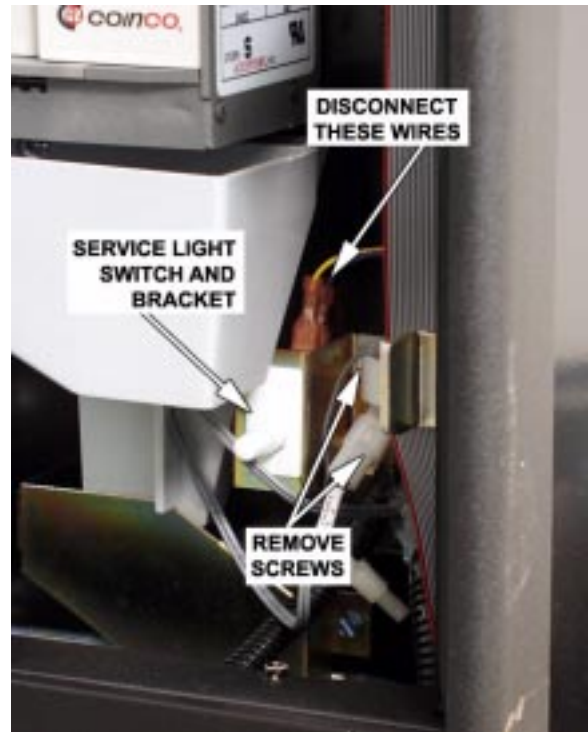

Figure 41

Model 431 Shoppertron Troubleshooting and Repair Guide

Y. Price Displays

Removal

WARNING

Prior to working on the machine, be sure it is unplugged from its power source.

1. Apply several pieces of tape across the front of the price display assembly to prevent its falling on the floor (figure 42).
2. Remove three panhead screws from the inside of the cabinet door (figure 43).
3. Swivel the price display assembly down from the top.
4. Carefully unplug the connector (figure 44).
5. Disassemble the PC board from the cover (if necessary).

Replacement

1. If previously removed, install the PC board assembly into the cover.
2. Carefully plug in the price display connector.
3. Make sure the sealant is in place to prevent air leaks (figure 44).

CAUTION

Take care not to pinch the price display wiring harness when performing the next step.

4. Lift the price display assembly into place.
5. Tape the top of the price display in place to keep it from falling.
6. Secure with three screws. Be careful and don't push too hard when starting the screws to avoid pushing the price display assembly out of its mounting.

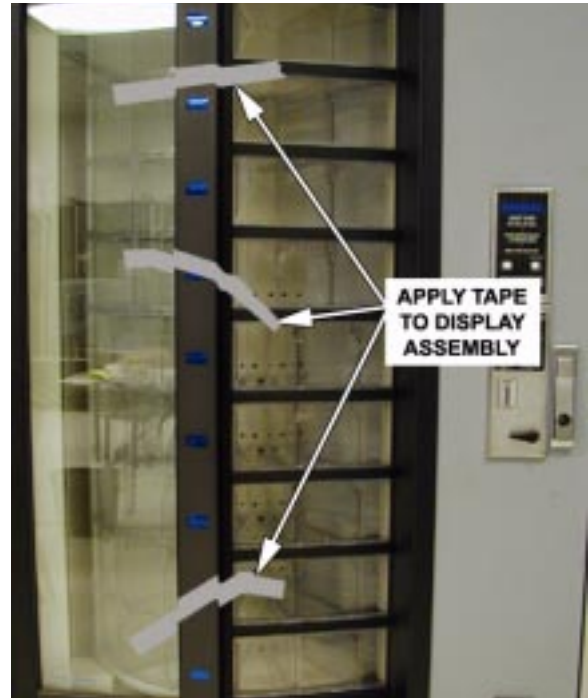

Figure 42



Figure 43

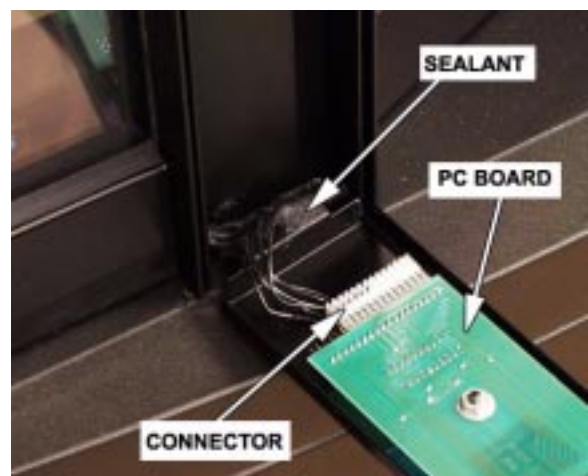

Figure 44

Model 431 Shoppertron Troubleshooting and Repair Guide

Z. EPROM

CAUTION

The EPROM (Erasable Programmable Read Only Memory) is highly susceptible to electrostatic discharge (ESD). Prior to continuing, familiarize yourself with ESD precautions (page 2).

Removal

WARNING

Prior to working on the machine, be sure it is unplugged from its power source.

CAUTION

Do not remove the new EPROM from its shipping carton until you are ready to use it.

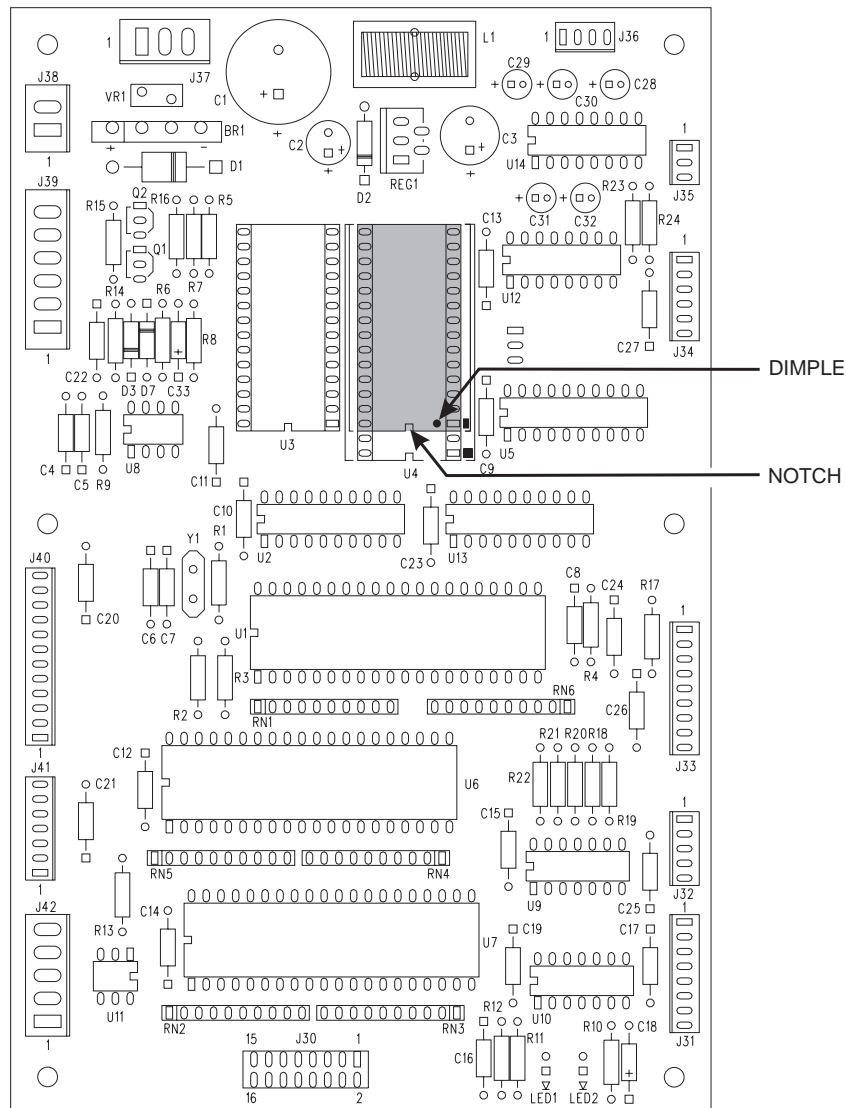

Model 431 Shoppertron Troubleshooting and Repair Guide

1. On the figure, see the shaded area representing EPROM U4. These devices have various means of showing how they are to be oriented on the circuit board. Some EPROMs will have a small notch which matches the notch printed on the controller board. Other EPROMs may have a small dimple as shown, others may have a painted stripe. Take note of where the locating mark is on the EPROM currently mounted on the controller board. Your new EPROM will be placed in that same orientation. Some EPROMs have 28 pins, so it does not use the entire socket. The shaded area on the figure is where the new EPROM will go, leaving the four holes at the bottom of the socket empty.
2. Carefully remove the old EPROM from the controller PCB. Use an EPROM removal tool or a thin tool such as a small screwdriver or knife blade to gently rock the EPROM from its socket.

USE AN IC PULLER
OR A SMALL
SCREWDRIVER TO
REMOVE THE EPROM

IMPORTANT:
LINE UP THE NOTCH
ON THE EPROM WITH
THE NOTCH ON THE
SOCKET

PLACE THE NEW
EPROM IN THE
SOCKET - BE SURE
ALL THE PINS ARE
IN THE CORRECT
HOLES

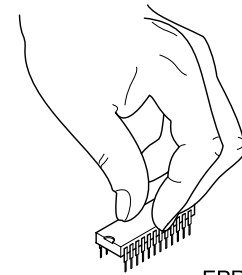
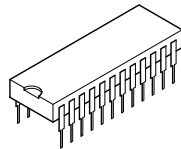
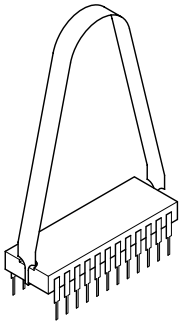

EPROM.iso

Replacement

1. Carefully insert the new EPROM in the controller board. **MAKE SURE THE LOCATING MARK (NOTCH, DIMPLE, STRIPE) ON THE NEW EPROM IS FACING THE SAME WAY AS ON THE OLD EPROM!** Make sure each of the pins is in its respective hole in the socket before pushing the EPROM into place.
2. Carefully seat the EPROM into place using uniform pressure all around.

Notes . . .

Appendix A. Wiring Diagram

A wiring diagram is provided on the next page for reference. Note: If this wiring diagram is older than the one included with your machine, do not use this one.

